

Basic Logical Operations (Fascinating)



In this section you will learn what are the basic logical operations and how to evaluate different logical expressions

Image from Star Trek © Paramount

James Tam

Logical AND

Truth table		
X	Y	X AND Y
False	False	False
False	True	False
True	False	False
True	True	True

Truth table		
X	Y	X AND Y
0	0	0
0	1	0
1	0	0
1	1	1

Logic gate

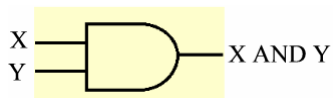

James Tam

Logical AND: An Example

	T	T	F	F	T	F
AND	F	T	F	T	T	F
<hr/>						
	F	T	F	F	T	F

James Tam

Logical OR

Truth table		
X	Y	X OR Y
False	False	False
False	True	True
True	False	True
True	True	True

Truth table		
X	Y	X OR Y
0	0	0
0	1	1
1	0	1
1	1	1

Logic gate

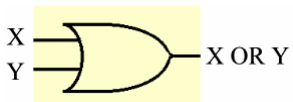

James Tam

Logical OR: An Example

	T	T	F	F	T	F
OR	F	T	F	T	T	F
<hr/>						
	T	T	F	T	T	F

James Tam

Logical NOT

Truth table	
X	Not X
False	True
True	False

Truth table	
X	Not X
0	1
1	0

Logic gate

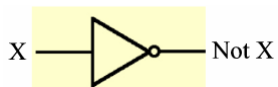

James Tam

Logical NOT: An Example

	T	T	F	F	T	F
NOT	F	F	T	T	F	T

James Tam

Logical NAND

Truth table			
X	Y	X AND Y	X NAND Y
False	False	False	True
False	True	False	True
True	False	False	True
True	True	True	False

Truth table			
X	Y	X AND Y	X NAND Y
0	0	0	1
0	1	0	1
1	0	0	1
1	1	1	0

Logic gate

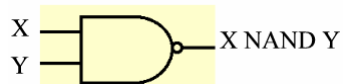

James Tam

Logical NAND: An Example

	T	T	F	F	T	F
AND	F	T	F	T	T	F
<hr/>						
	F	T	F	F	T	F
NAND	T	F	T	T	F	T

James Tam

Logical NOR

Truth table			
X	Y	X OR Y	X NOR Y
False	False	False	True
False	True	True	False
True	False	True	False
True	True	True	False

Truth table			
X	Y	X OR Y	X NOR Y
0	0	0	1
0	1	1	0
1	0	1	0
1	1	1	0

Logic gate

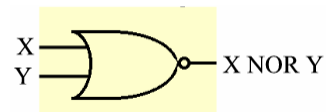

James Tam

Logical NOR: An Example

	T	T	F	F	T	F
OR	F	T	F	T	T	F
<hr/>						
	T	T	F	T	T	F
NOR	F	F	T	F	F	T

James Tam

Logical Exclusive OR (XOR)

Truth table		
X	Y	X XOR Y
False	False	False
False	True	True
True	False	True
True	True	False

Truth table		
X	Y	X XOR Y
0	0	0
0	1	1
1	0	1
1	1	0

Logic gate

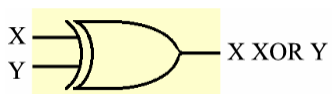

James Tam

Logical XOR: An Example

	T	T	F	F	T	F
XOR	F	T	F	T	T	F
	T	F	F	T	F	F

James Tam

Reasons For Learning About Logic

Hardware perspective

- The computer is built using logic circuits

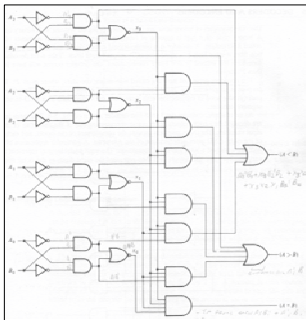

James Tam

Reasons For Learning About Logic (2)

Software perspective

- Logic is common-place in computer programs



James Tam

You Should Now Know

The different types of logical operations that a computer may perform

- AND
- OR
- NOT
- NAND
- NOR
- XOR

How logic gates form an important part of computers

James Tam