

Computer Science

CPSC 231: Introduction to Computer Science for Computer Science Majors I Spring 2021

Jonathan Hudson, Ph.D.
Instructor
Department of Computer Science
University of Calgary

Friday, 30 April 2021

Copyright © 2021



What is a Computer?



What is a Computer?

- Definitions vary
- **Boring definition:**
 - A boxy device with a typewriter-like interface that stores and processes information

What is a Computer?

- **Criminal Code of Canada (s. 342.1):**
 - “computer system” means a device that, or a group of interconnected or related devices one or more of which,
 - a) contains computer programs or other data, and
 - b) pursuant to computer programs,
 - i. performs logic and control, and
 - ii. may perform any other function;
 - “computer program” means data representing instructions or statements that, when executed in a computer system, causes the computer system to perform a function;

What is a Computer?

- **Legal definition under the Uniform Computer Information Transactions Act (UCITA), USA:**
 - An electronic device that accepts information in digital or similar form and manipulates it for a result based on a sequence of instructions
- **Dictionaries:**
 1. One who computes
 2. A tool that receives, processes and presents data



JEAN RIDDLE MCGRAW

ULMAR STABLER

JEAN SCOTT

What is a Computer?

- Does not need to be “electronic”
 - (can also be mechanical, optical, biological, ...).
- “Digital or similar form” not accurate either (may be quantum data, DNA).
- **“Tool” succinct, accurate description.**
 - Example:
 - What is a car? How many people drive? Why do you drive?
 - Car is a tool that makes living in Calgary easier
 - Computers are the same, but for scientific investigation.

Abacus

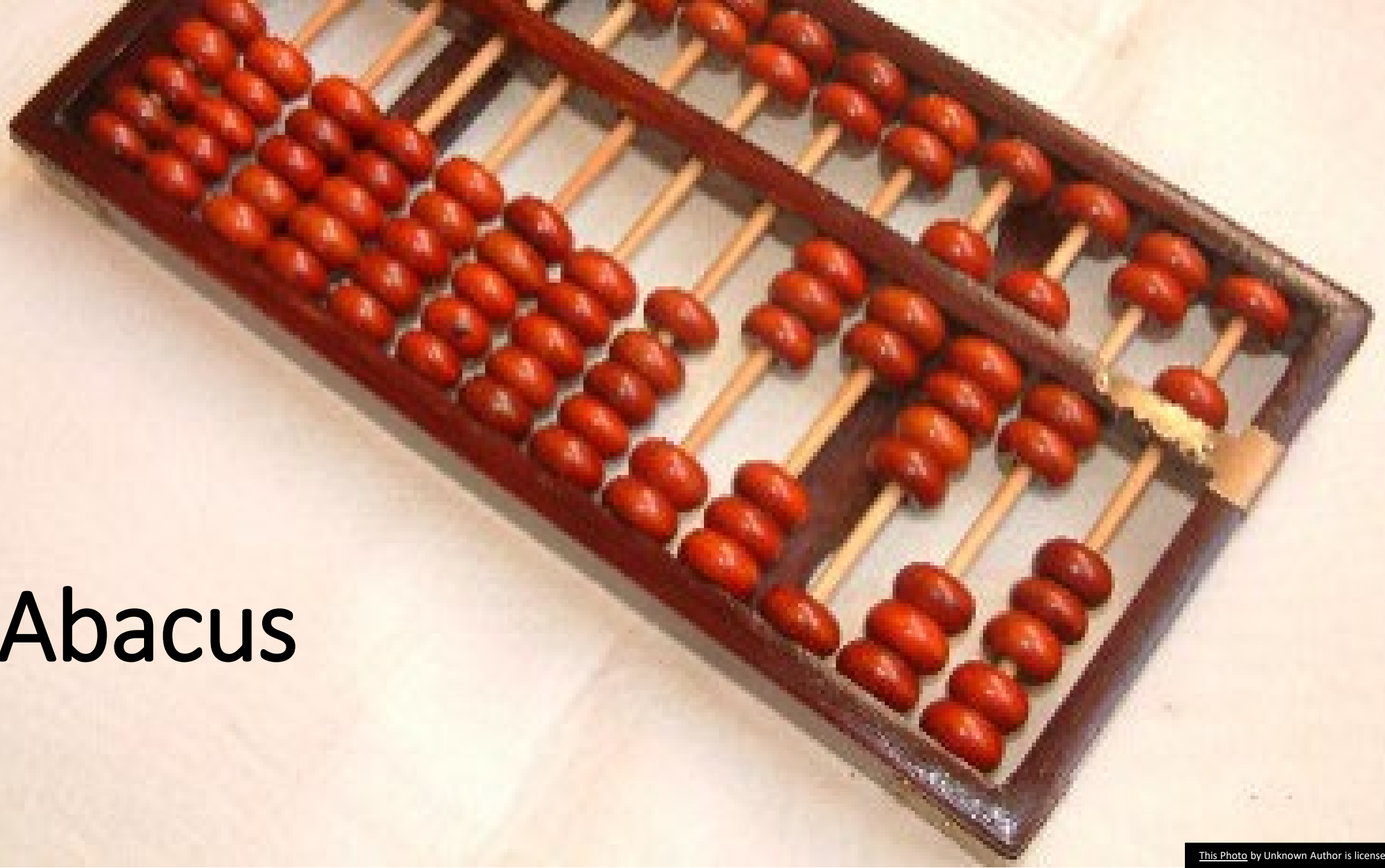

Difference Engine (Charles Babbage)

- A **difference engine** is an automatic **mechanical calculator** designed to tabulate **polynomial functions**. (~1822)
- A mathematician, philosopher, inventor and mechanical engineer, Babbage originated the concept of a **digital programmable computer**.
- “**father of the computer**”
- In **1991**, a **functioning** difference engine was constructed from Babbage's original plans.

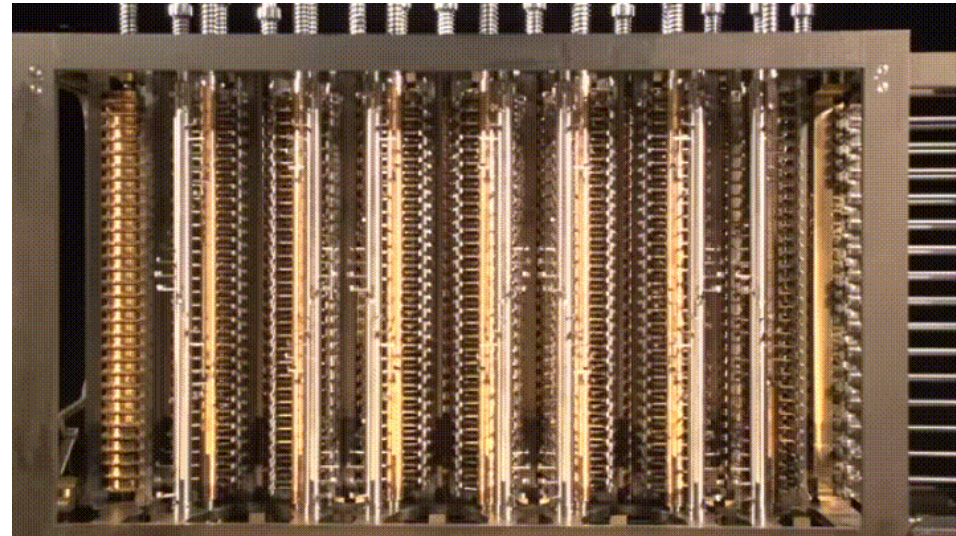
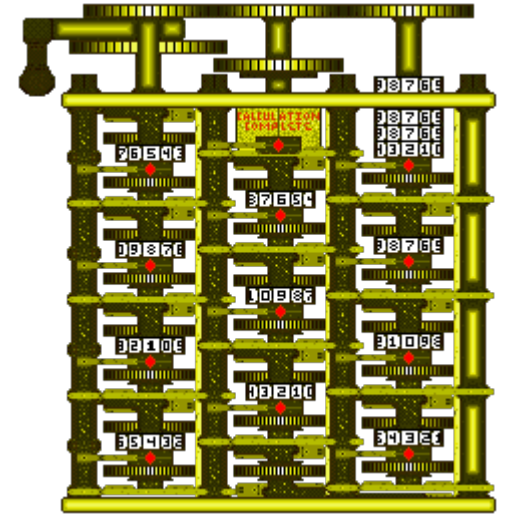



Computers – Difference Engine

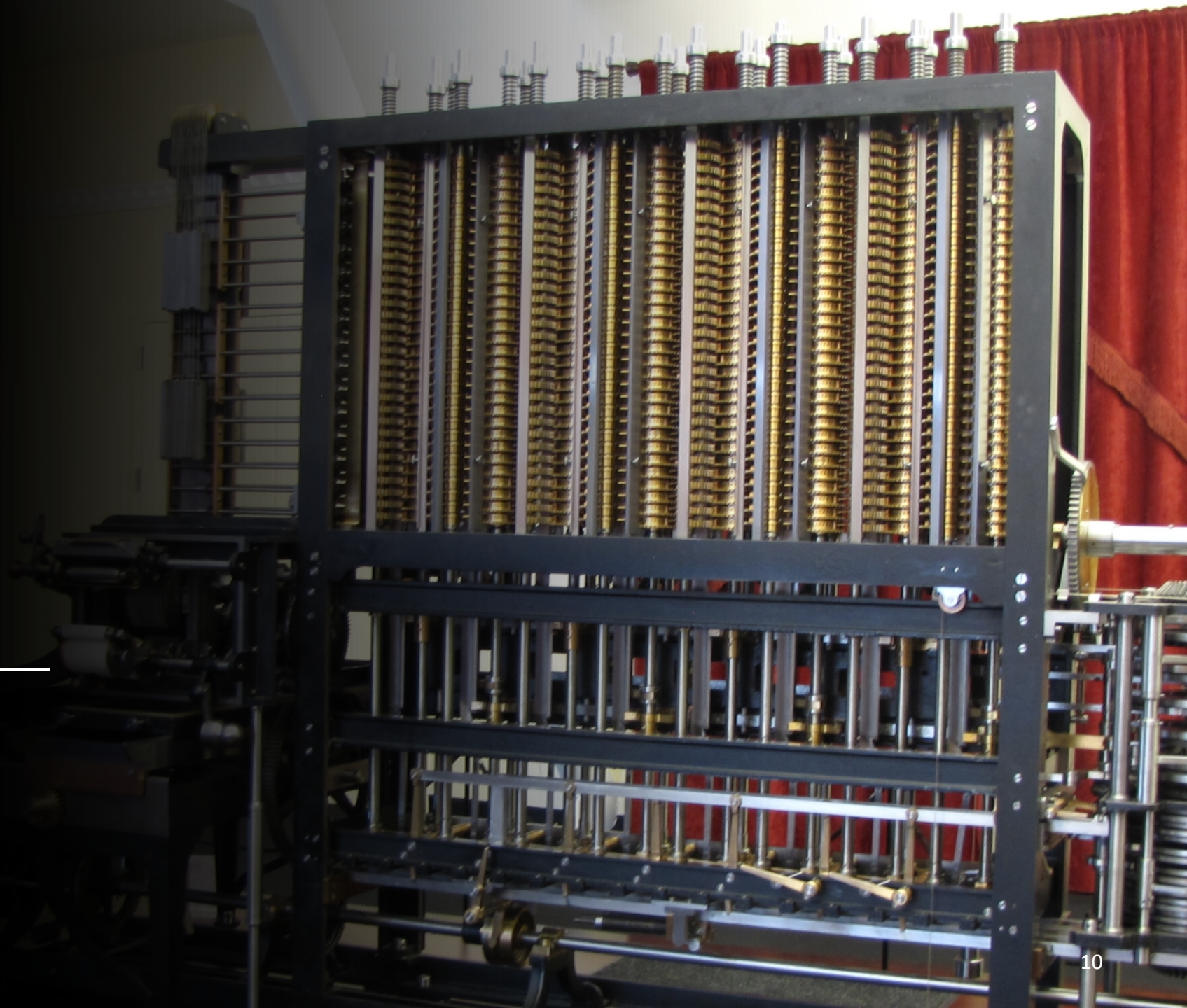



Computers – Difference Engine

Ada Lovelace

- Mathematician and writer
- Daughter of Lord Byron (*interesting fellow*)
- **Worked with Charles Babbage**
- **Maybe the first programmer**
 - (At least first evidence of)
- Early **philosophy** of computer science (**The effects of technology on people**)
- 'Halt and Catch Fire' trivia -> Cameron wants to name BIOS Lovelace



[This Photo](#) by Unknown Author is licensed under [CC BY-SA](#)

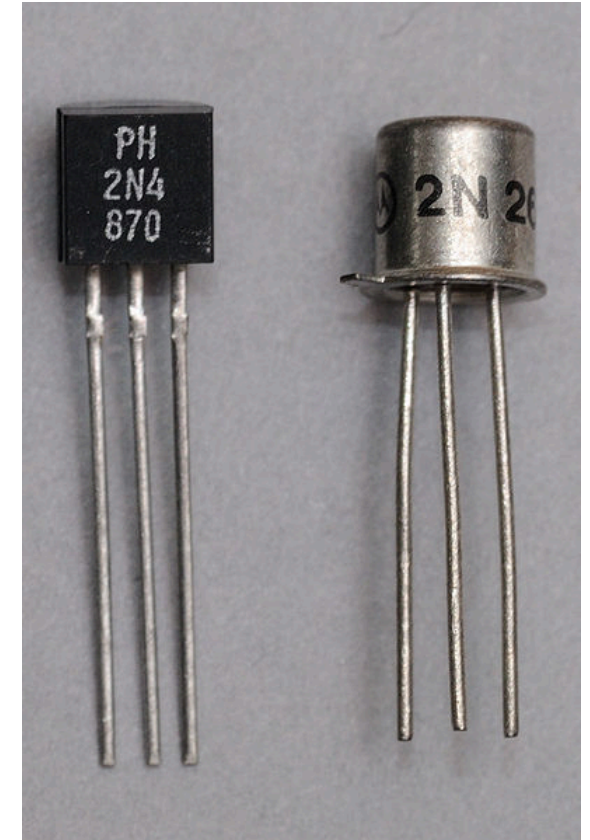
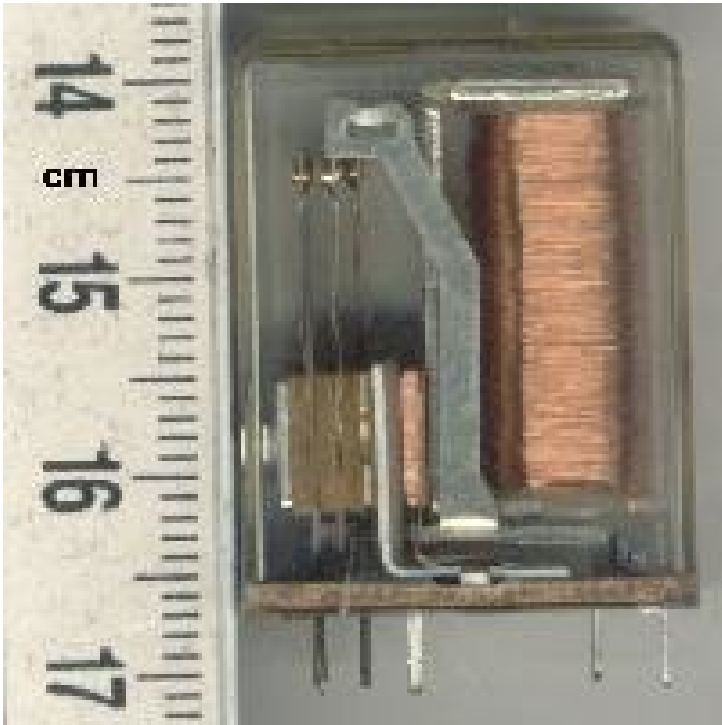

Electric Switches

(Left to Right) Relay, vacuum tube, transistor



Computers - ENIAC

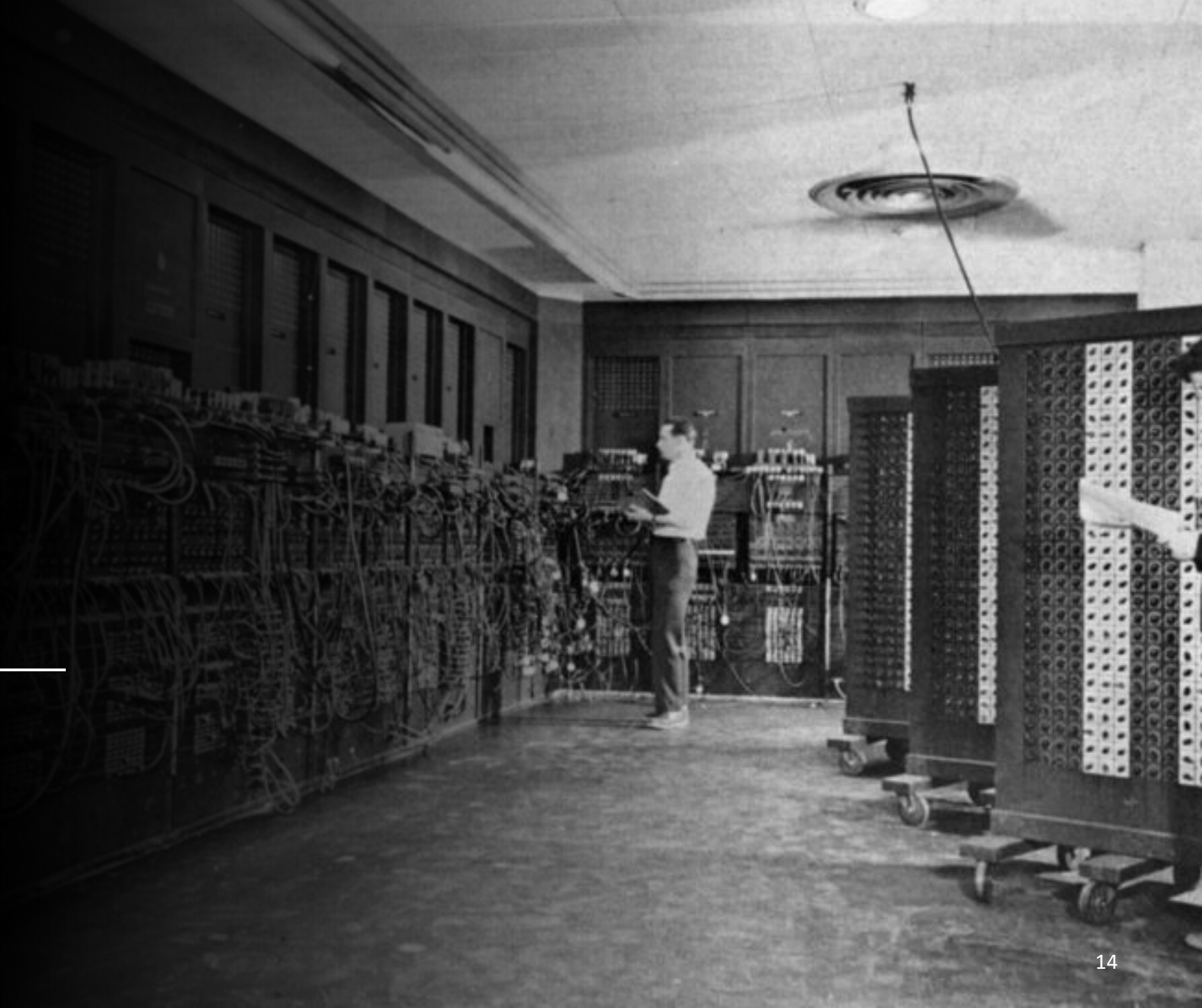

Modern Computers

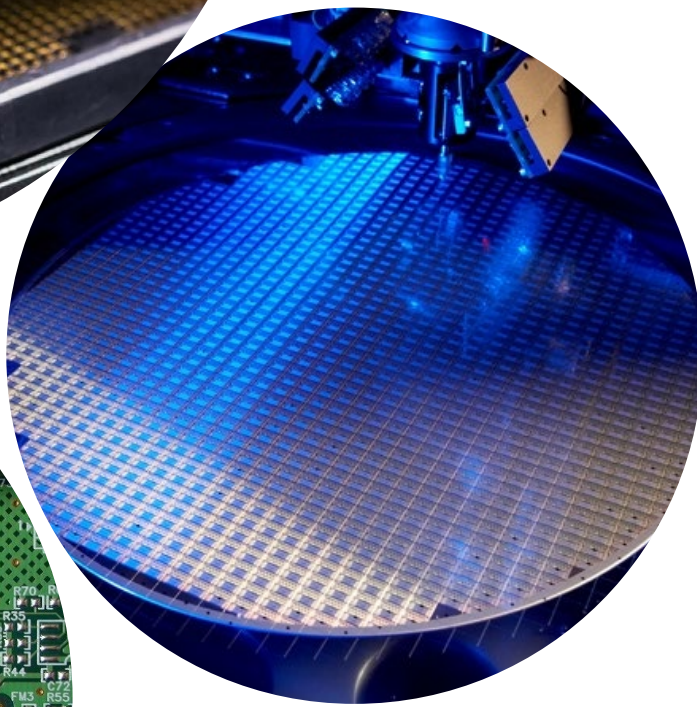
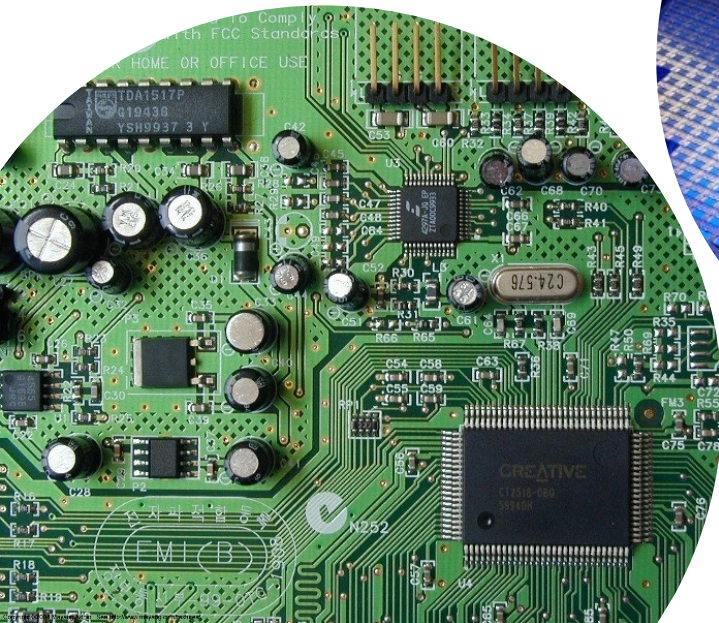
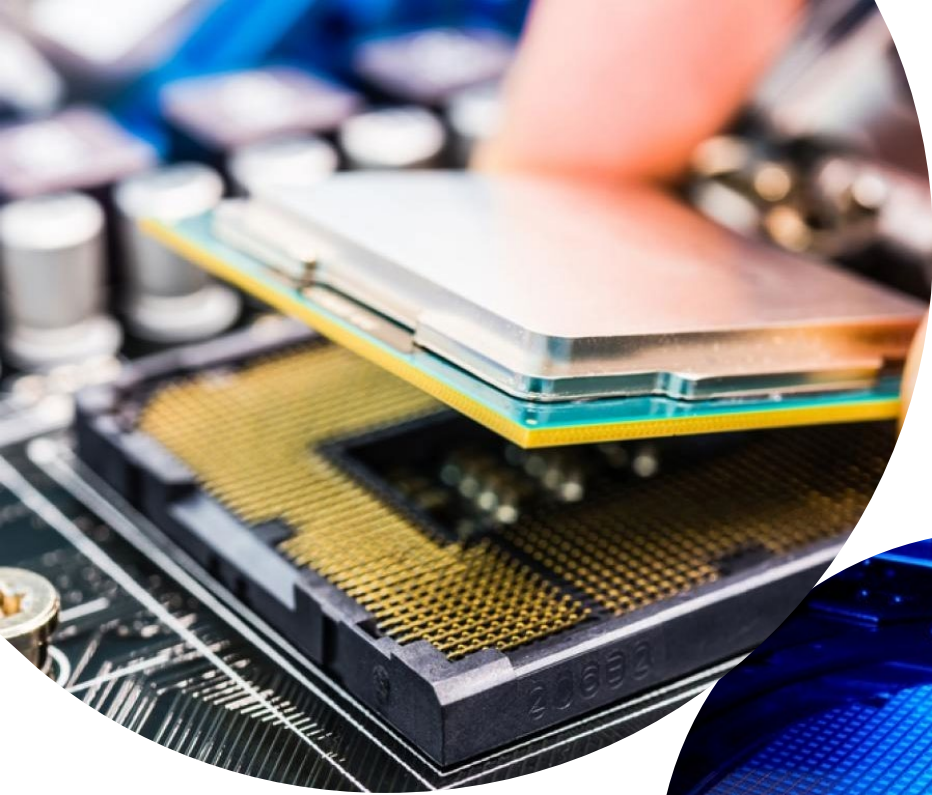

Modern Computers

- **Integrated Circuits** (1959) patent by Robert Noyce. Co-inventor of **integrated circuit** made of **silicon**.
- William Shockley was the manager of a research group at Bell Labs that included John Bardeen and Walter Brattain. The three scientists were jointly awarded the 1956 Nobel Prize in Physics for "their researches on semiconductors and their discovery of the transistor effect."
- Considered founder of **silicon valley**, his company spawned **Intel/AMD/National Semi** conductors

Modern Computers

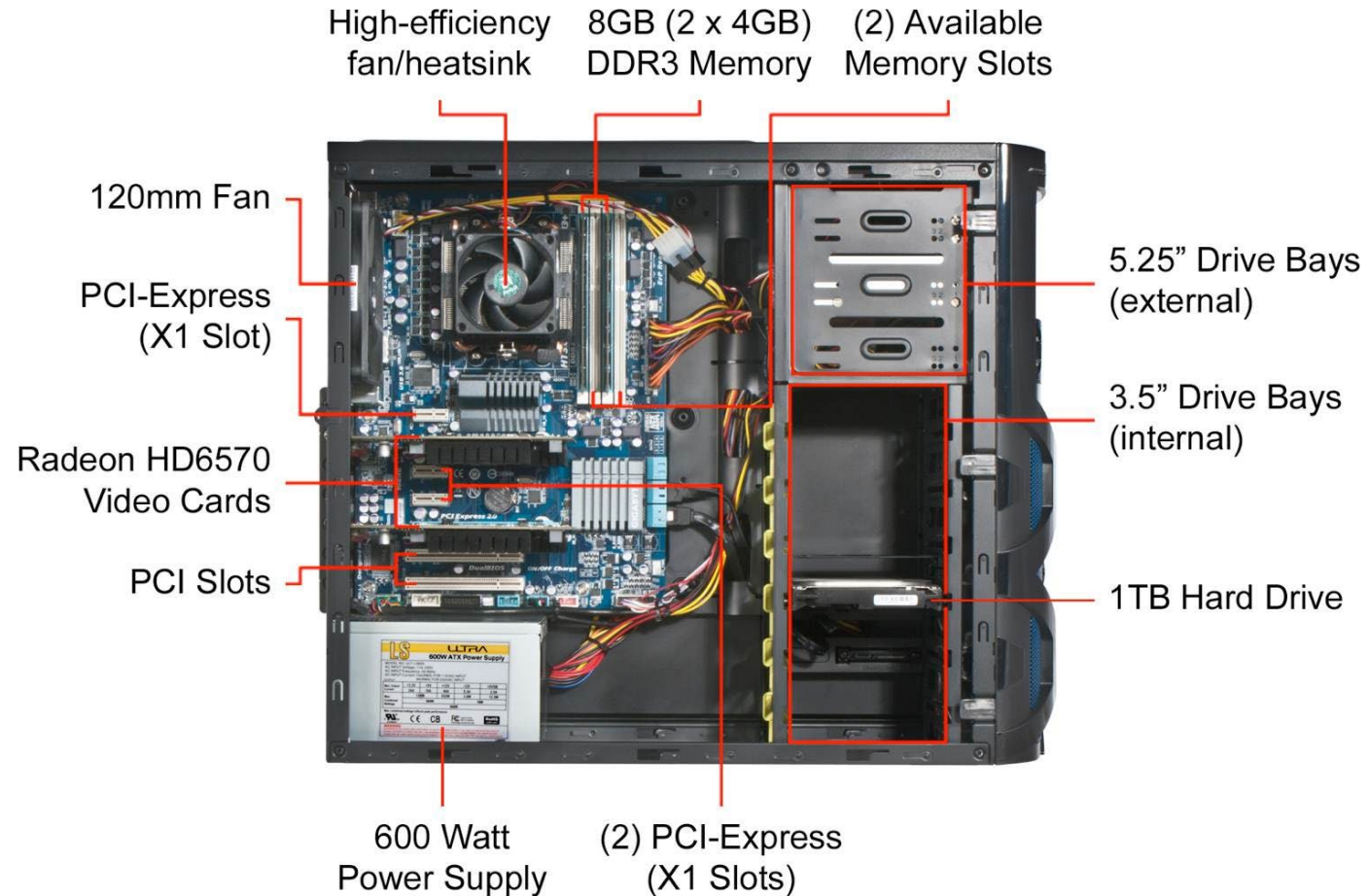

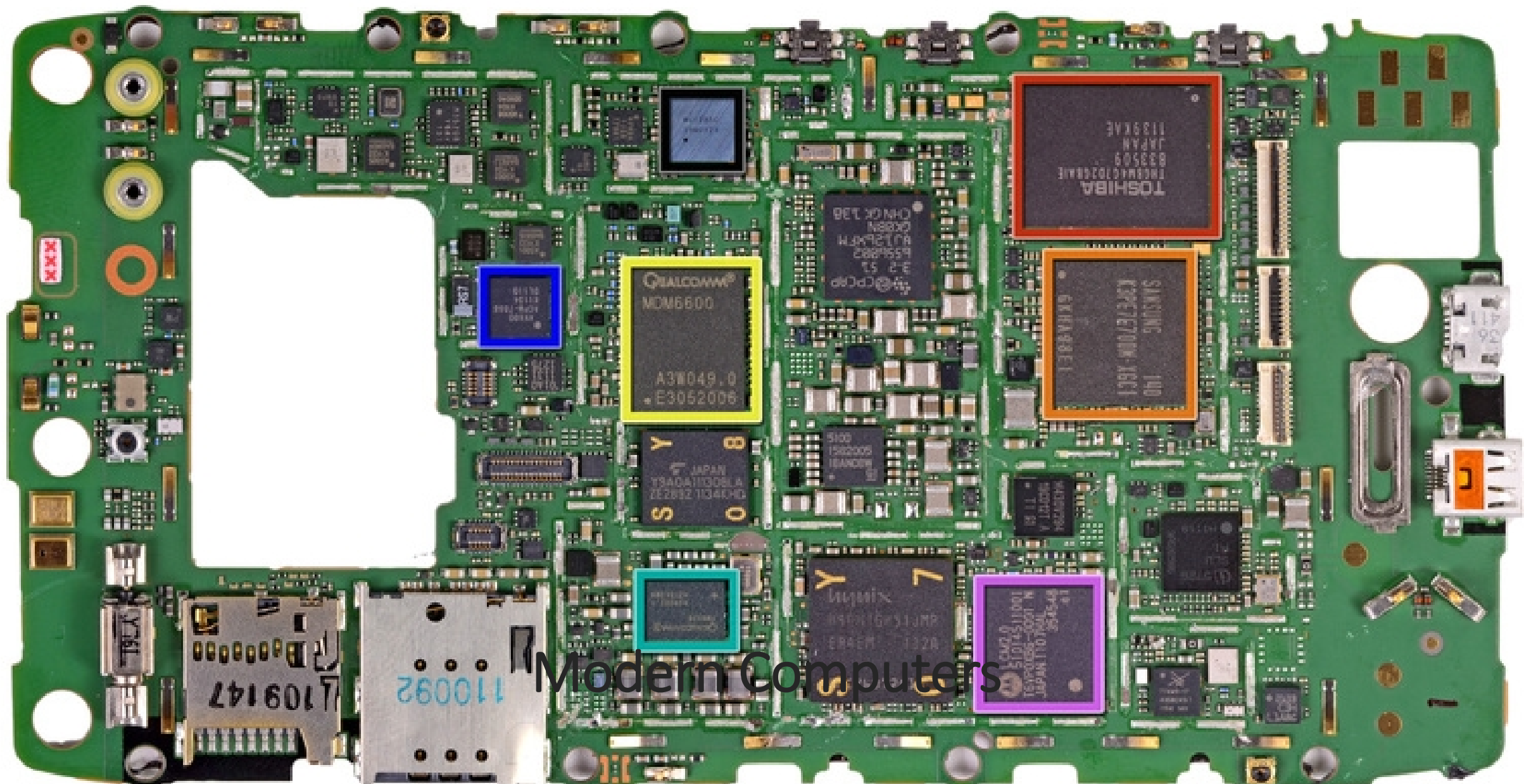

Modern Computers



Modern Computers

Moore's Law

Moore's Law

- **“The complexity for minimum component costs has increased at a rate of roughly a factor of two per year ... Certainly over the short term this rate can be expected to continue, if not to increase. Over the longer term, the rate of increase is a bit more uncertain, although there is no reason to believe it will not remain nearly constant for at least 10 years.” Gordon Moore 1965**

42 Years of Microprocessor Trend Data

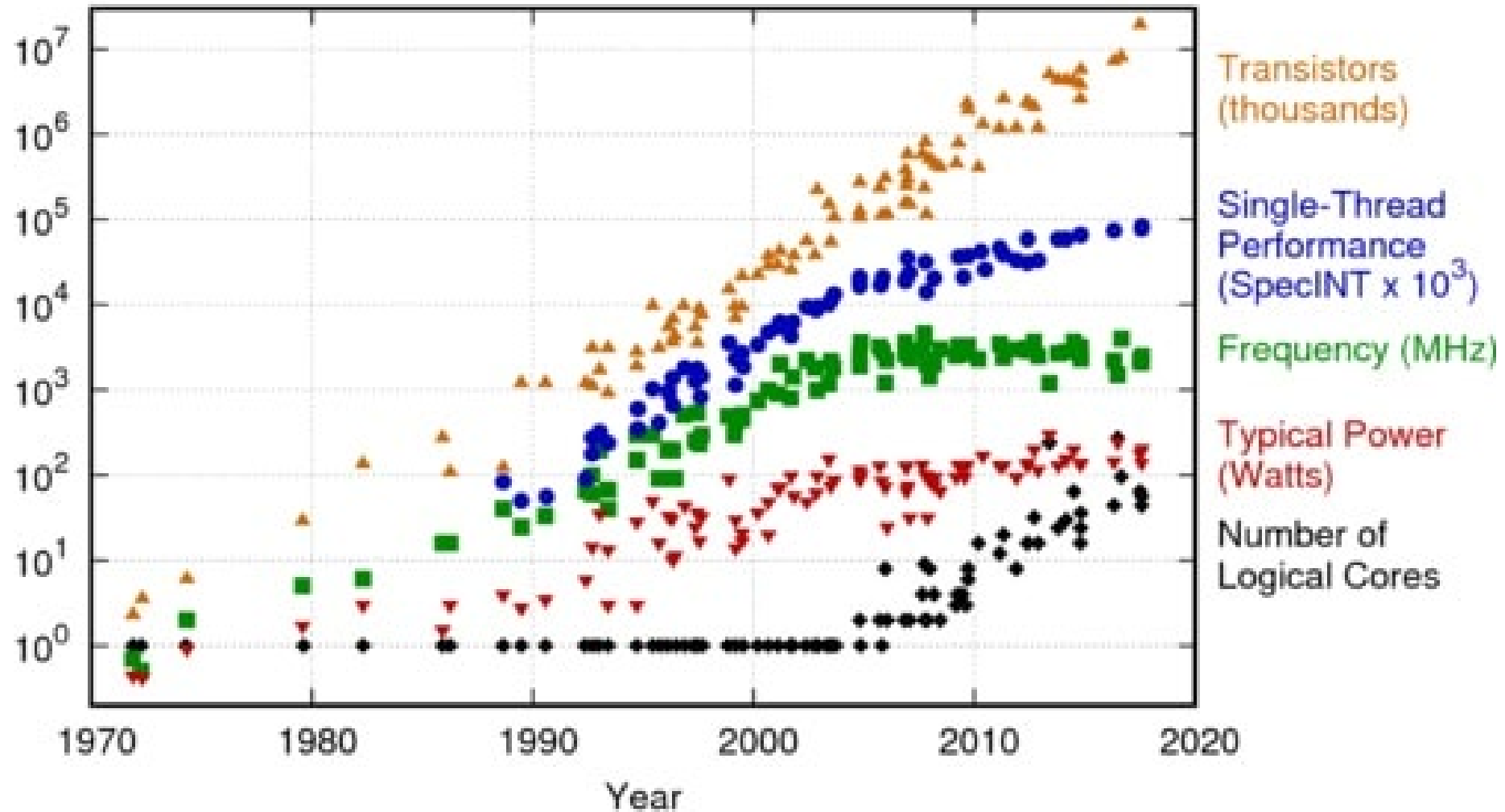

Original data up to the year 2010 collected and plotted by M. Horowitz, F. Labonte, O. Shacham, K. Olukotun, L. Hammond, and C. Batten
New plot and data collected for 2010-2017 by K. Rupp

Von Neumann

- Mathematician and Physicist
- **Modern CPUs are based off of Von Neumann (Princeton) Architectures (1945)**
 - Program instructions are data just like data processed by program
 - Control Unit tracks current step of program in memory
- Stored-program architecture (versus ENIAC types where you'd input program my physical configuration steps)

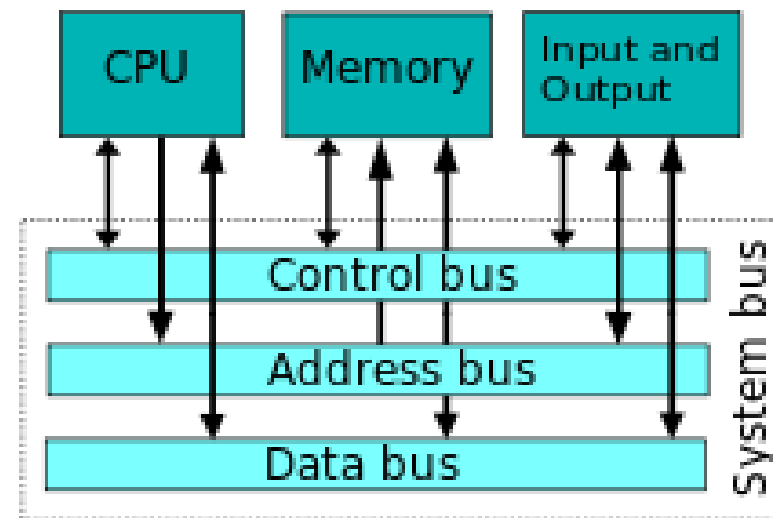
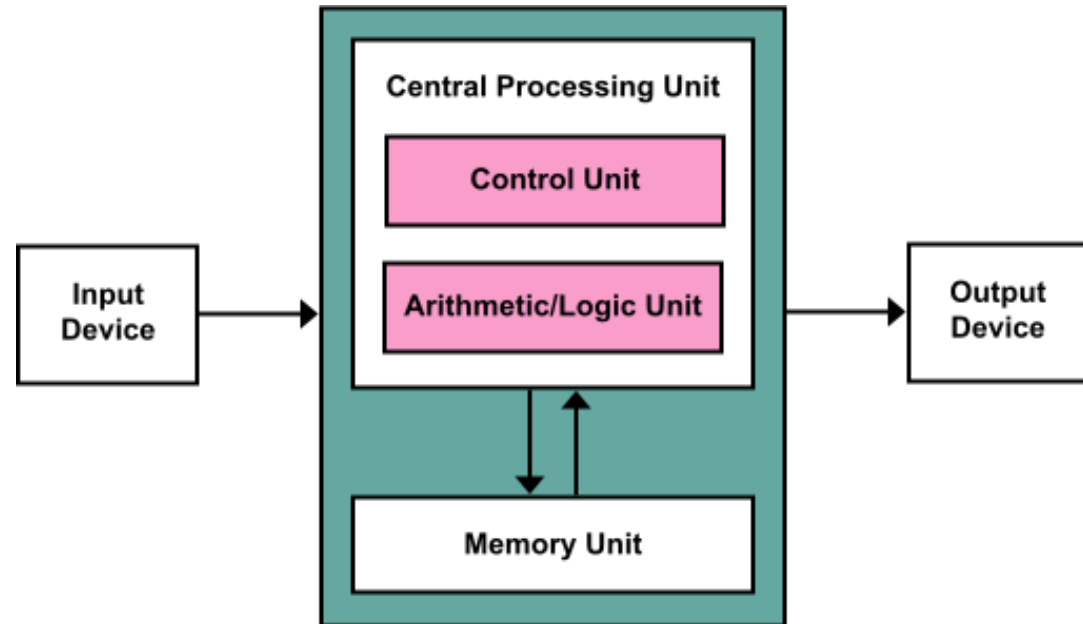

What is Computer Science?

“Science” is:

What is Computer Science?

- **Science:** The effort to discover and increase understanding of how something works through controlled methods (experimentation), observation, and analysis.

Computer Science

- **Definition:**
 - **The scientific study of computation and computer technology, hardware and software**
 - **The study of the theoretical foundations of information and computation, and their implementation and application in computer systems**
- **Combination of mathematics and engineering disciplines (even some philosophy!)**

Computer Science

“Computer science is no more about computers than astronomy is about telescopes.”

- Edsger Dijkstra



Portrait of Edsger W. Dijkstra
Photograph by Hamilton Richards
Licensed under the Creative Commons
Attribution-Share Alike 3.0 Unported
license
<http://creativecommons.org/licenses/by-sa/3.0/deed.en>

Onward to ... programming!

Jonathan Hudson
jwhudson@ucalgary.ca
<https://pages.cpsc.ucalgary.ca/~hudsonj/>



UNIVERSITY OF
CALGARY