

Brief History of Computer Science

CPSC 231: Introduction to Computer Science for Computer Science Majors I
Spring 2021

Jonathan Hudson, Ph.D.
Instructor
Department of Computer Science
University of Calgary

Friday, 30 April 2021

Copyright © 2021



**UNIVERSITY OF
CALGARY**

Ada Lovelace

- Mathematician and writer
- Daughter of Lord Byron (*interesting fellow*)
- Worked with Charles Babbage
- Maybe the first programmer
- (At least first evidence of)
- Early philosophy of computer science (The effects of technology on people)



Difference Engine (Charles Babbage)

A difference engine is an automatic mechanical calculator designed to tabulate polynomial functions. (~1822)

A mathematician, philosopher, inventor and mechanical engineer, Babbage originated the concept of a digital programmable computer.

“father of the computer“

In 1991, a functioning difference engine was constructed from Babbage's original plans.

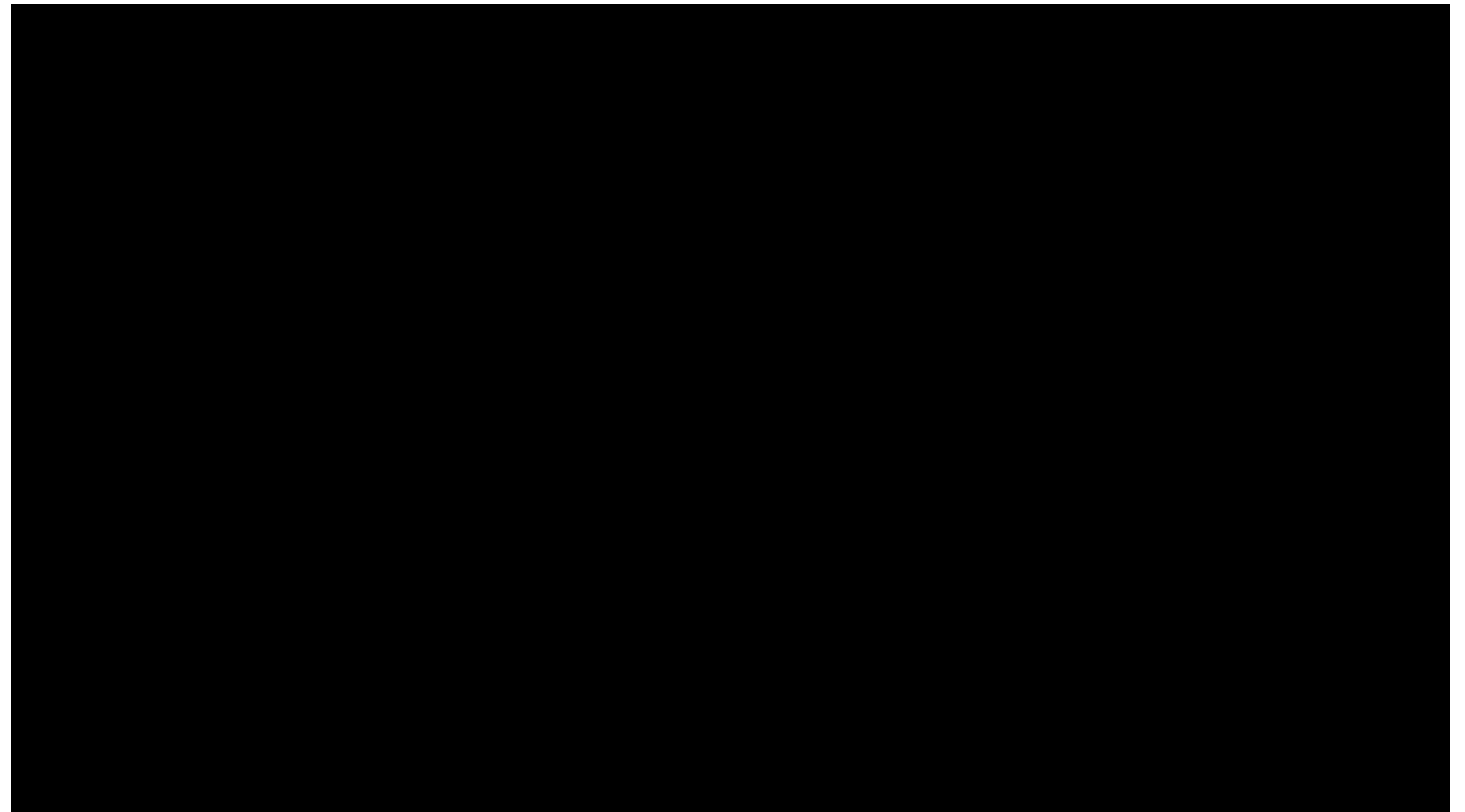

Claude Shannon

- Electrical application of Boolean algebra could be used for digital calculation (Master's thesis)
- Field of information theory (1948) all information can be in bits, in this paper.
- Together these things are considered the fundamentals of modern computers
- Sending digital information (instead of analog which was everyone else was doing)
- Data compression

Bombe (WWII Bletchley Park)

- A machine to reverse engineer rotator selection for enemy messages



Collosus (WWII Bletchley Park)

- Find patterns in cipher text

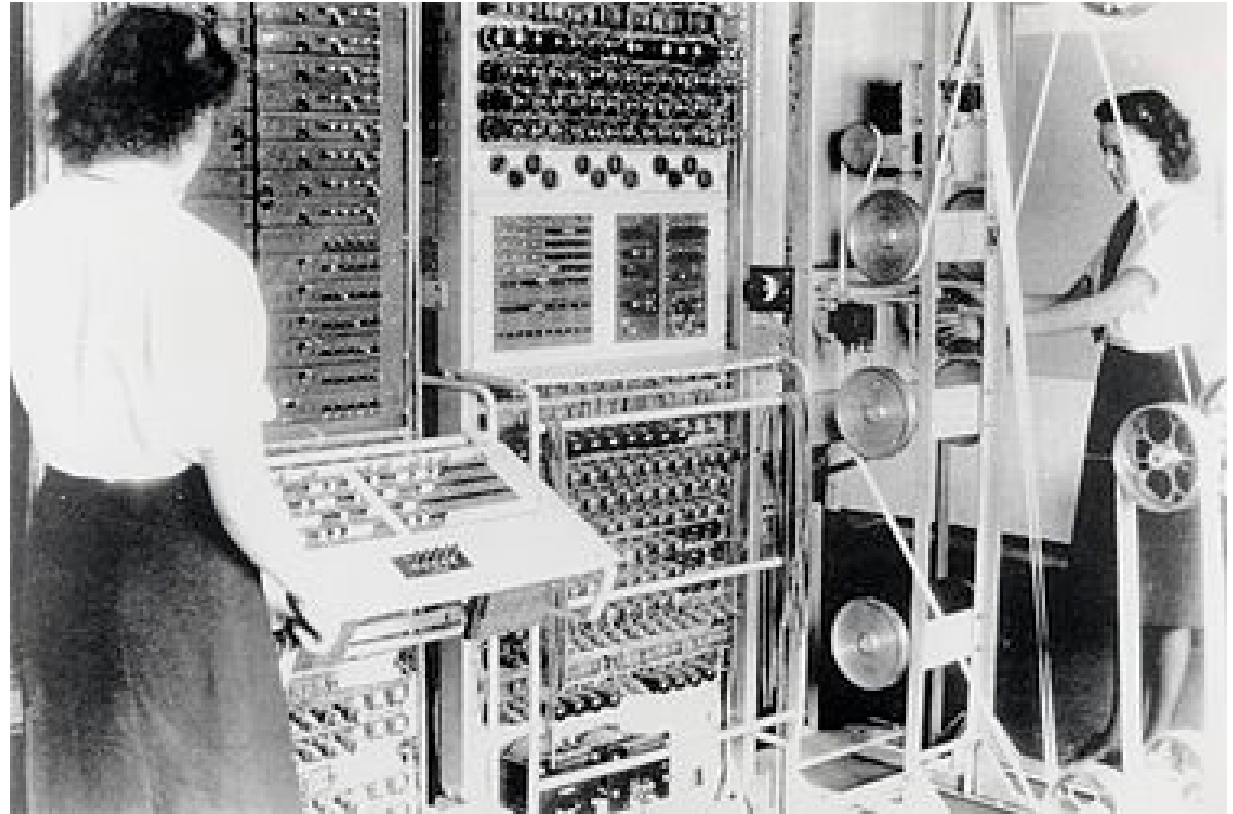
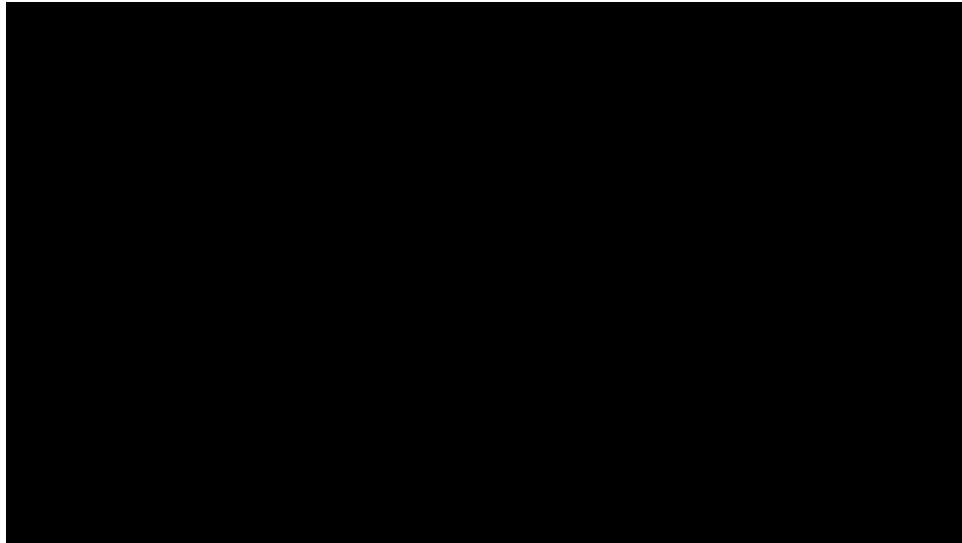

ENIAC

- Artillery firing tables (1946)
- 20 hours down to 30 seconds
- \$7 million
- Calculations needed for thermonuclear weapons
- 20,000 vacuum tube
- 1500 relays
- 70,000 resistors
- 10,000 capacitors
- 7200 crystal diodes

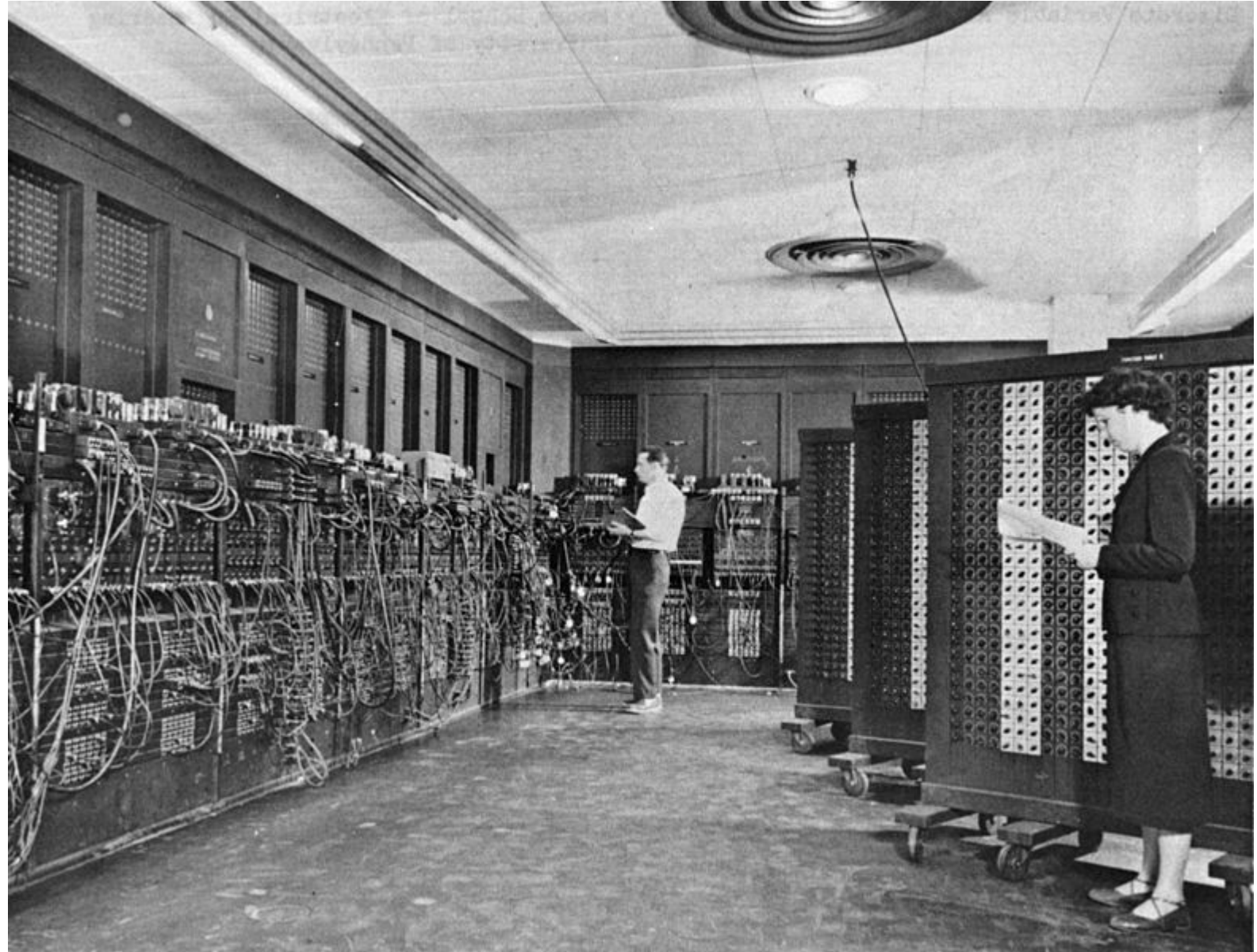

Alan Turing

- Father of Computer Science and Artificial Intelligence
- Worked at Bletchley Park
- Mathematician, logician, computer scientist, philosopher, cryptanalyst
- Turing Machine

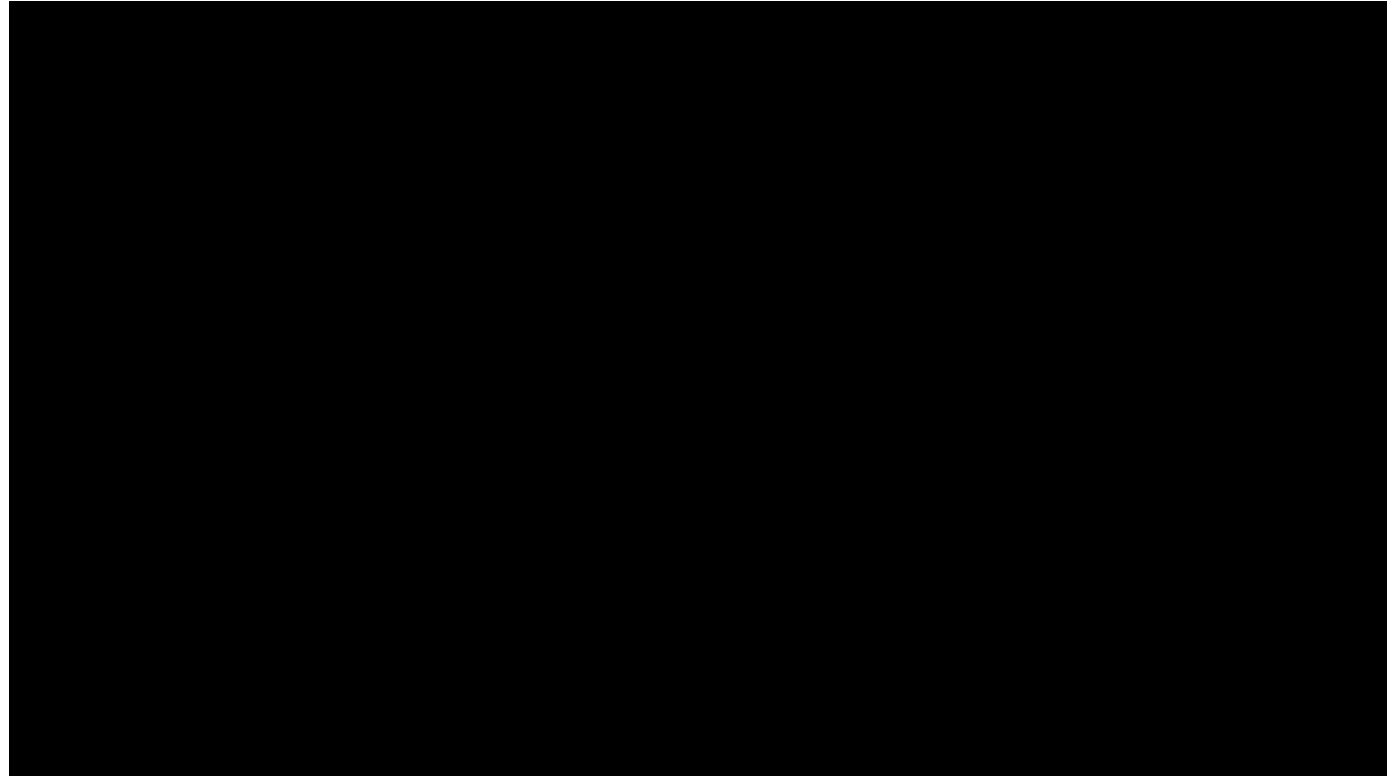

Halting Problem

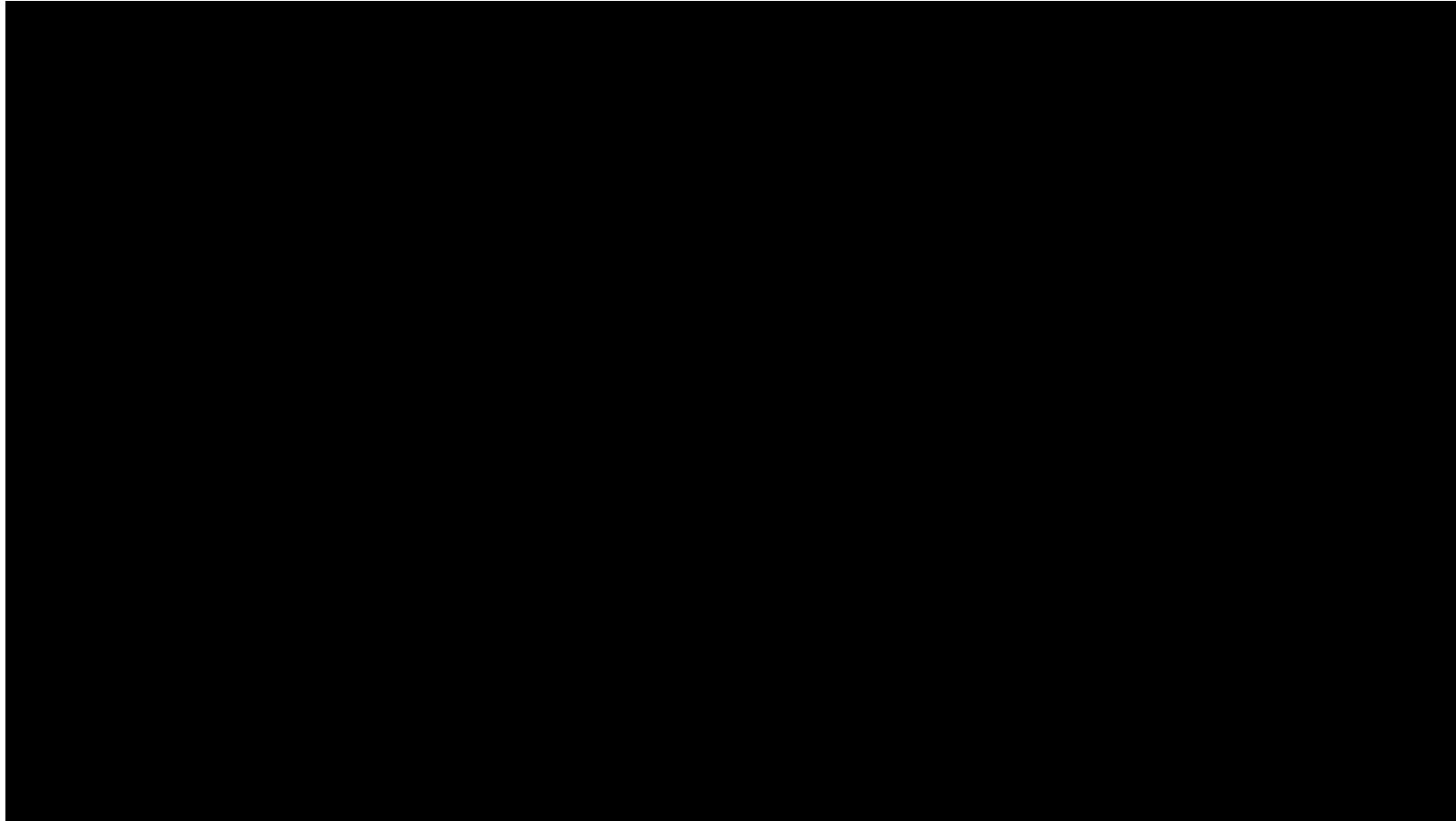

Turing Test

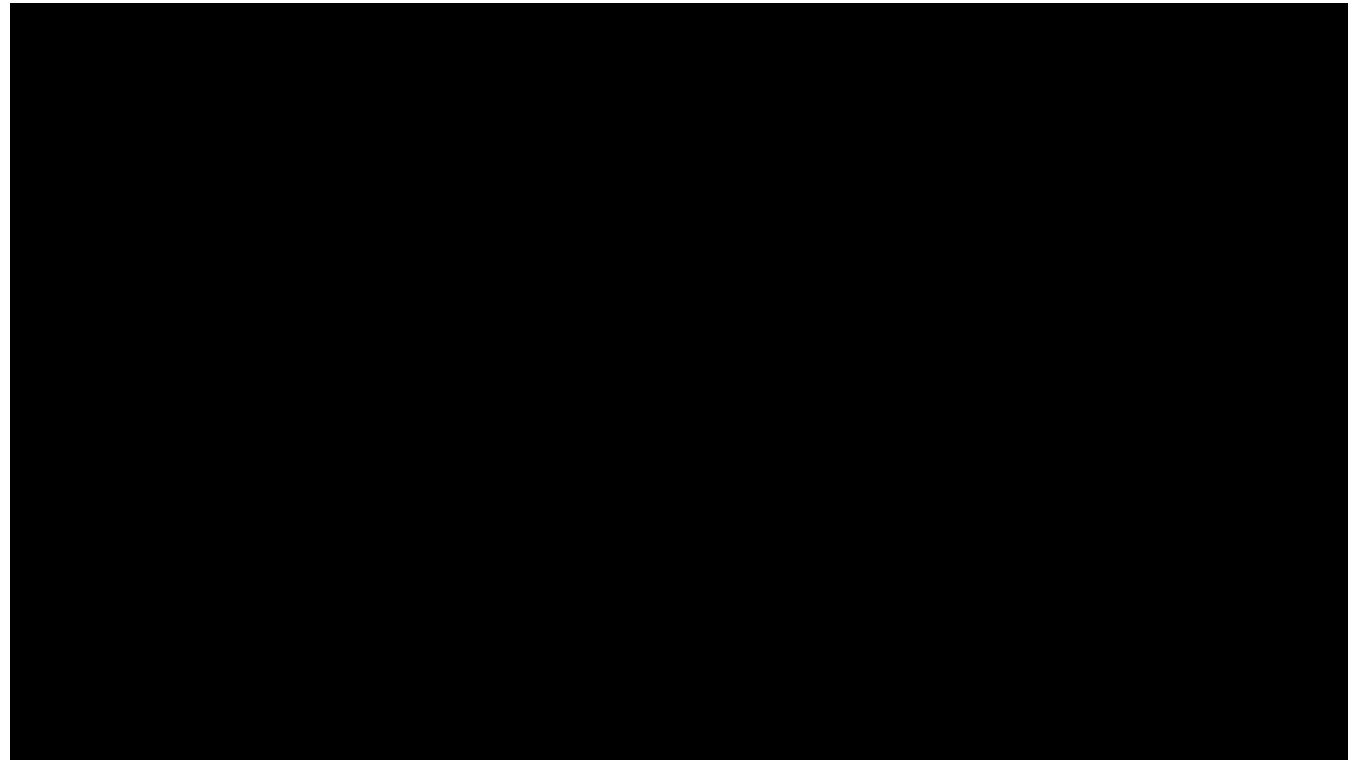

$P=NP$ or $P \neq NP$

- The theory of NP-completeness has its roots in computability theory, which originated in the work of Turing, Church, Godel, and others in the 1930s
- 2002 poll, 61 mathematicians and computer scientists said that they thought P probably didn't equal NP , to only nine who thought it did — and of those nine, several told the pollster that they took the position just to be contrary.
- The equivalency of P and NP is one of the seven problems that the Clay Mathematics Institute will give you a million dollars for proving

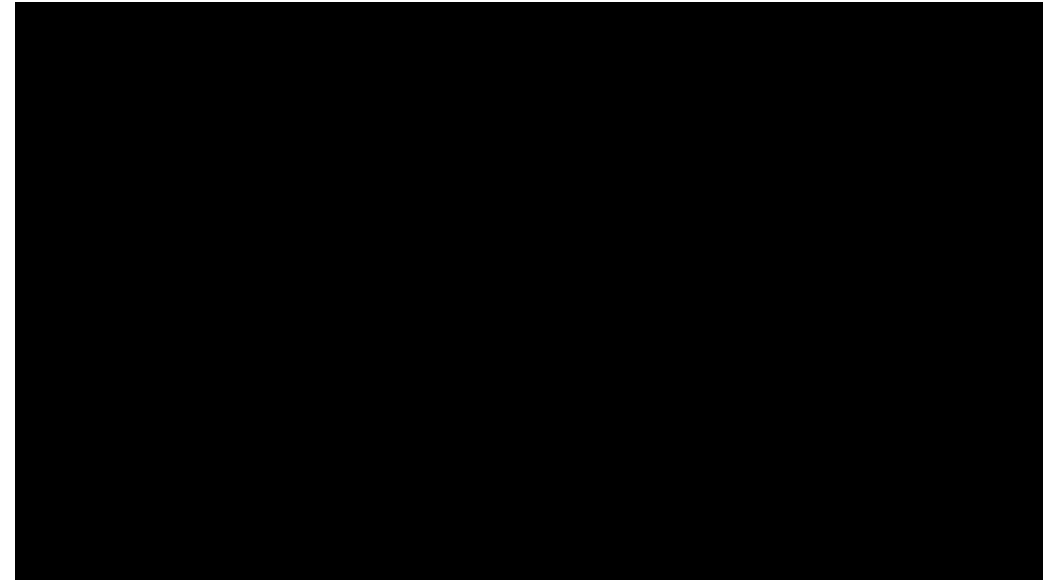

1944 Harvard Mark I

- Electromechanical Computer
- Von Neumann
- We should store programs in memory with the data the program operates on
- Before we always setup the program as an external encoding

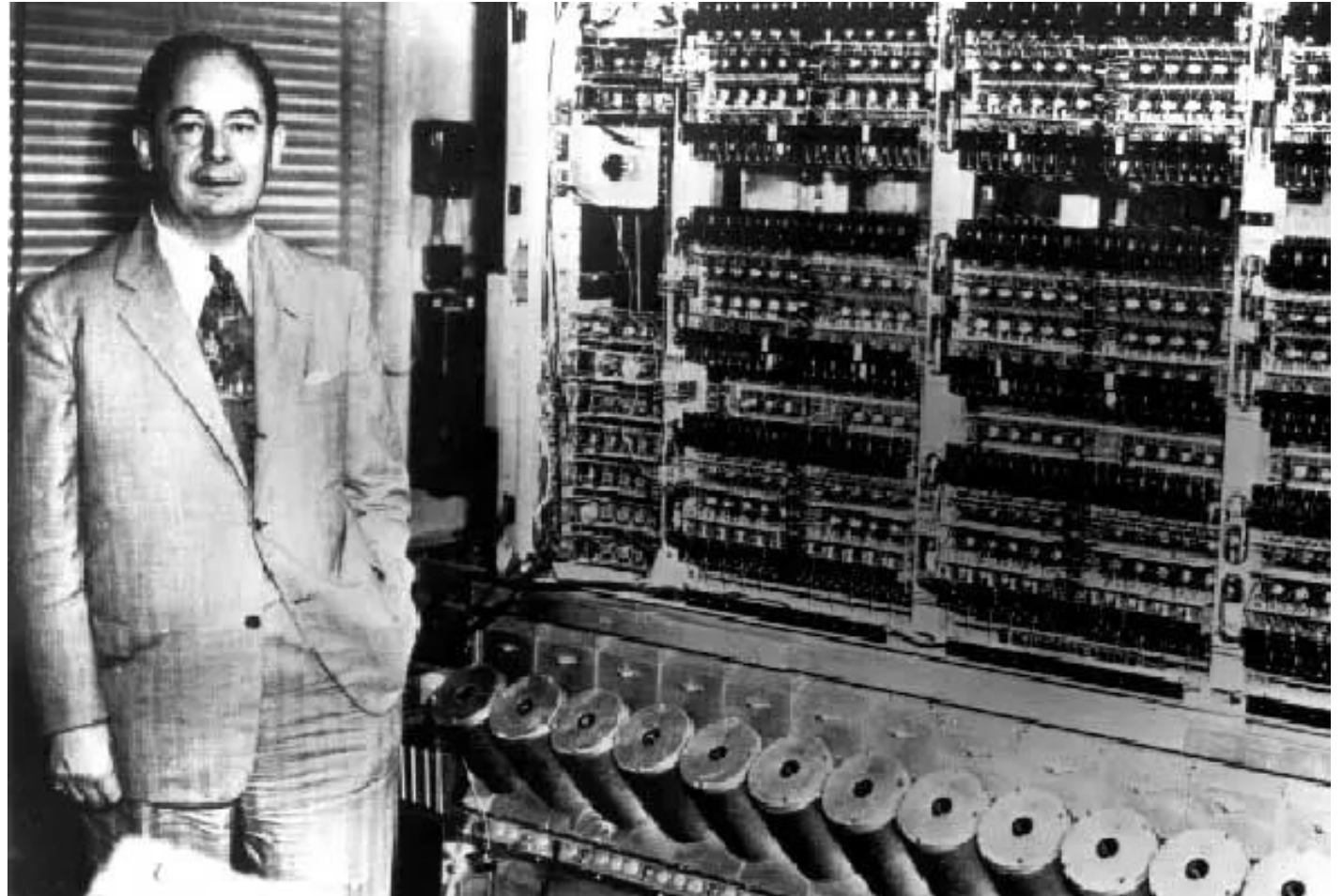

Von Neumann

- Mathematician and Physicist
- Modern CPUs are based off of Von Neumann Architectures (1945)

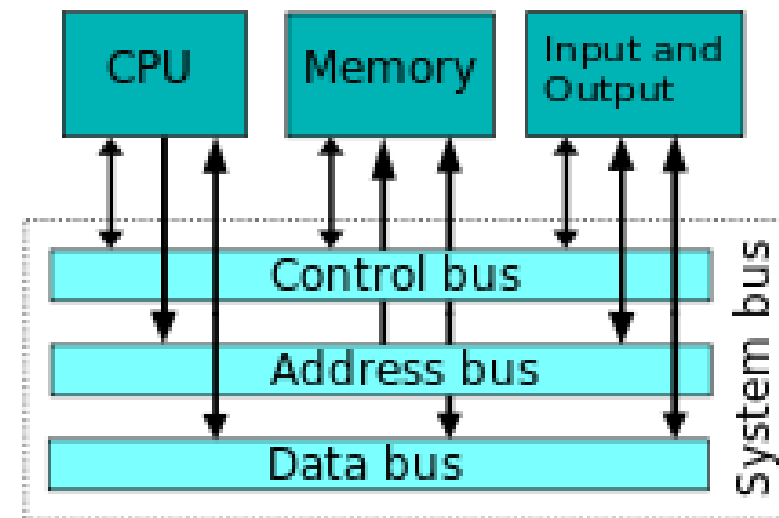
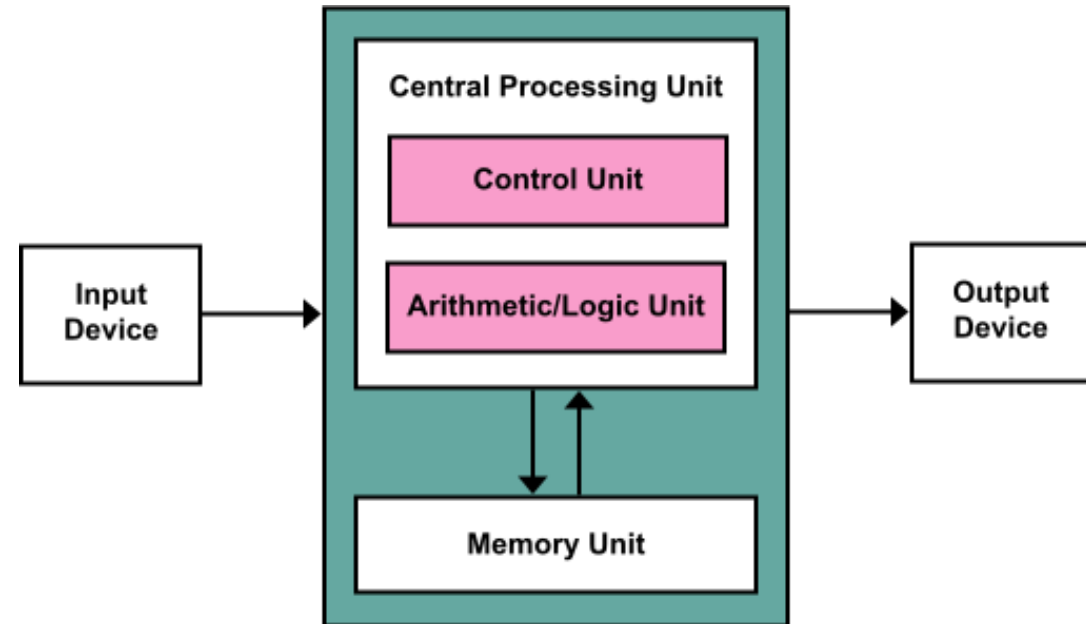

Grace Hopper

- US Navy Rear Admiral
- Programmer on Von Neumann's Harvard Mark I
- Compiler -> Write high level code which is changed into something the computer understands (1952)
- COBOL (still around for mainframes)
- Bug - often (but erroneously) credited to Grace Hopper. In 1946, she traced an error in the Harvard Mark II to a moth trapped in a relay.
- Popularized term of debugging



First Hard Drive (1953)

- 5 MB 5 * 1024 bytes
- People take single pictures that take up more space than this
- byte — coined by Werner Buchholz in June 1956 during the early design phase for the IBM Stretch computer.[11][12][13][14]

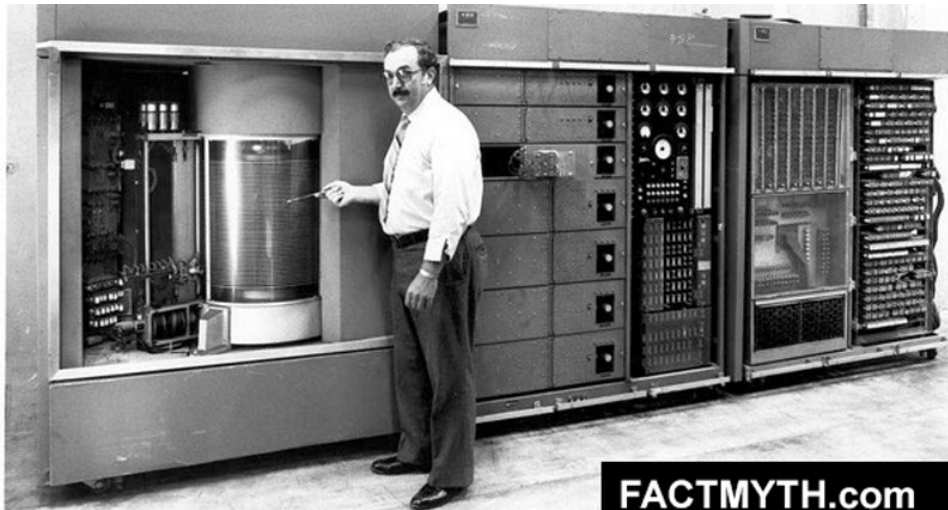

FACTMYTH.com

The first Hard Disk Drive was invented in 1953 and introduced in 1956 by IBM. The unit came with the IBM 305 RAMAC and measured 1.5 sq meters.



ITY OF
ARY

Punch Cards

Concept goes back before computers for tabulating data

Early form of interacting with computers without having to switch a whole bunch of switches into an initial state

Where the word 'patch' comes from (putting something over a misplaced hole)

Into mid-80s until hard drives became of reasonable cost
Learning to program you learned to punch out your program and then carry to machine to run

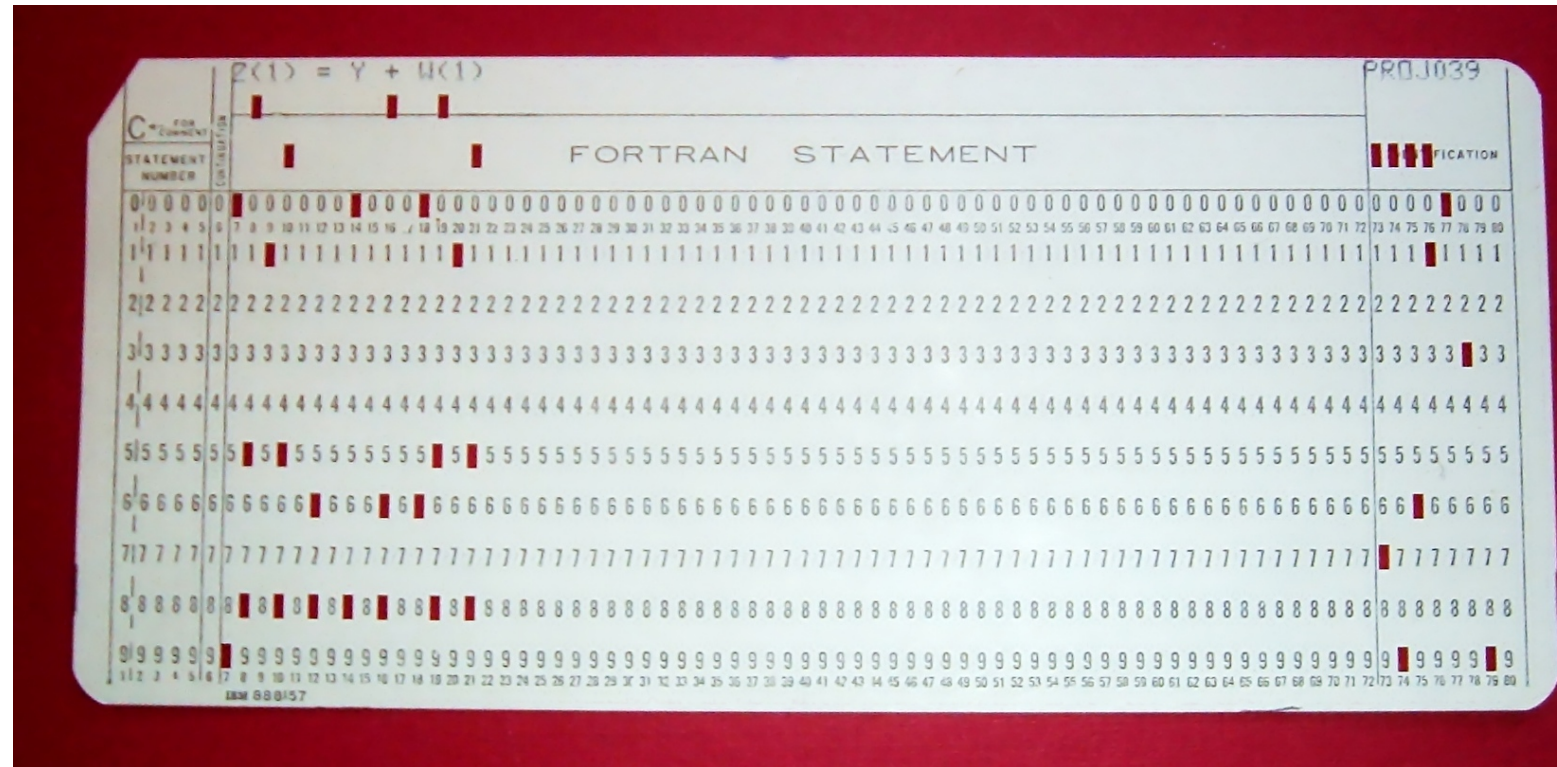

Modern Computers

Integrated Circuits (1959) patent by Robert Noyce. Co-inventor of integrated circuit.

William Shockley was the manager of a research group at Bell Labs that included John Bardeen and Walter Brattain. The three scientists were jointly awarded the 1956 Nobel Prize in Physics for "their researches on semiconductors and their discovery of the transistor effect."

Considered founder of silicon valley, his company spawned Intel/AMD/National Semi conductors

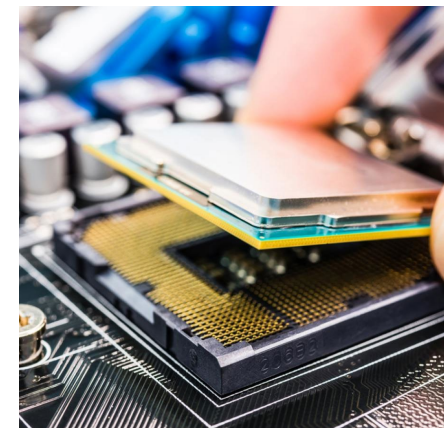
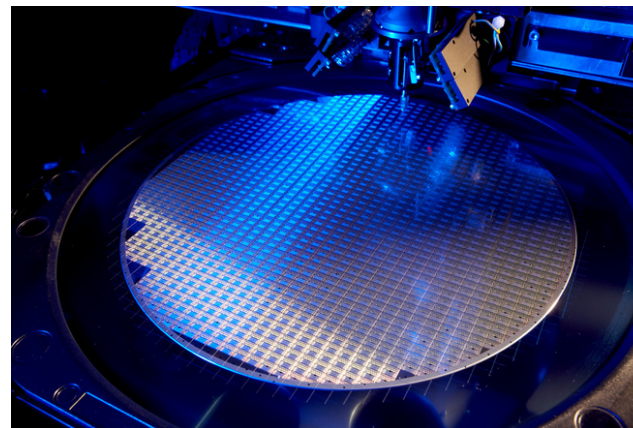
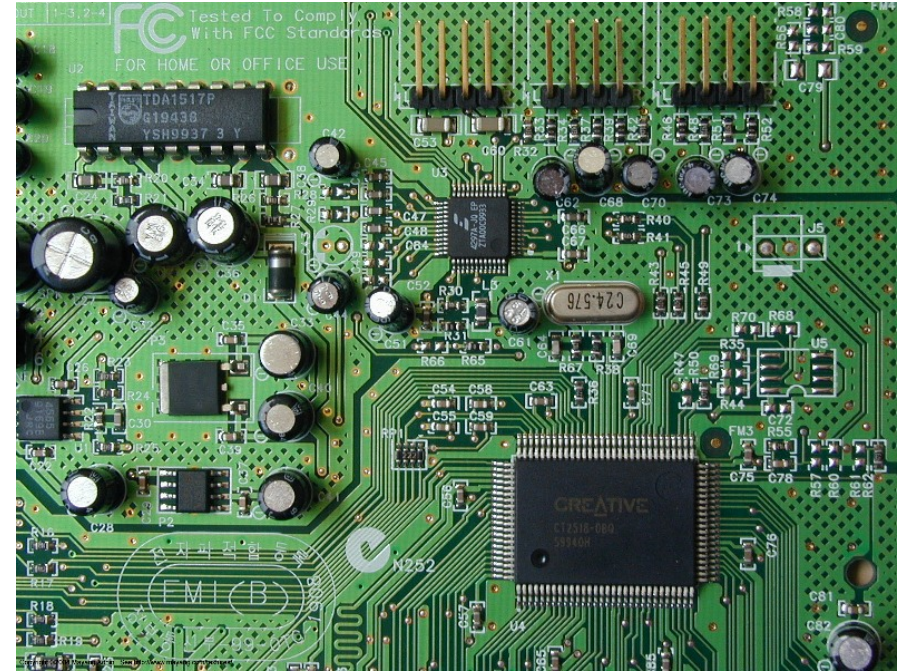

Mother of all Demos

Douglas Engelbart

Human-computer interactions

Live demo with a computer mouse, video conferencing, teleconferencing, hypertext, word processing, real time editing (1968)

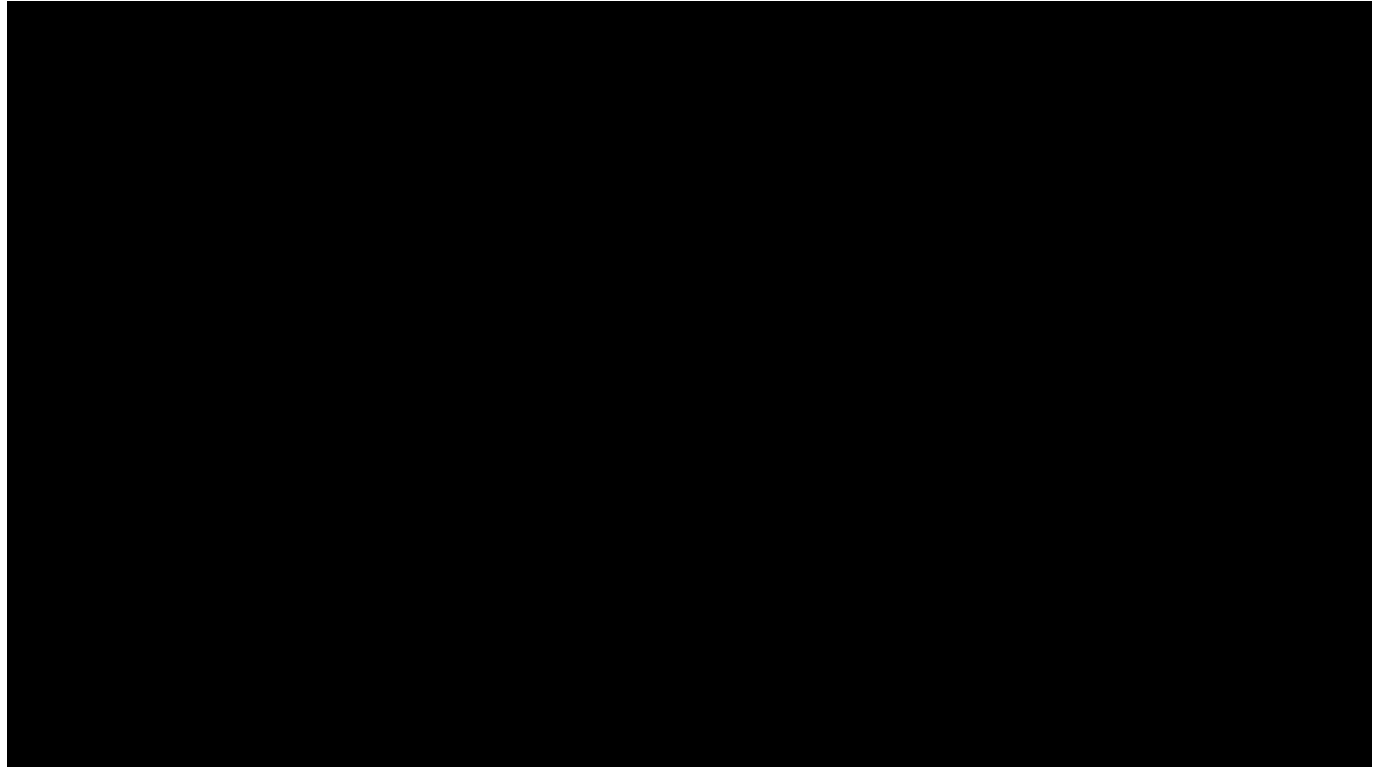

Margaret Hamilton

Director of MIT software engineering group that made on-board software for the Apollo Space Program (Seen here, 1969)

Coined term software engineer

Lots of software engineering developments, modelling, design, languages, robust systems



Fourier Transform

1822 Joseph Fourier
-some functions written as
sum of infinite harmonics
(sin and cos waves)

Guess what often falls into
this, digital signals such as
wireless/wired network
signals.

Fast-Fourier Transform ->
1965 basic ideas
popularized (top 10
algorithms of 20th century)

(Two others included
Fortran compiler and
quicksort)

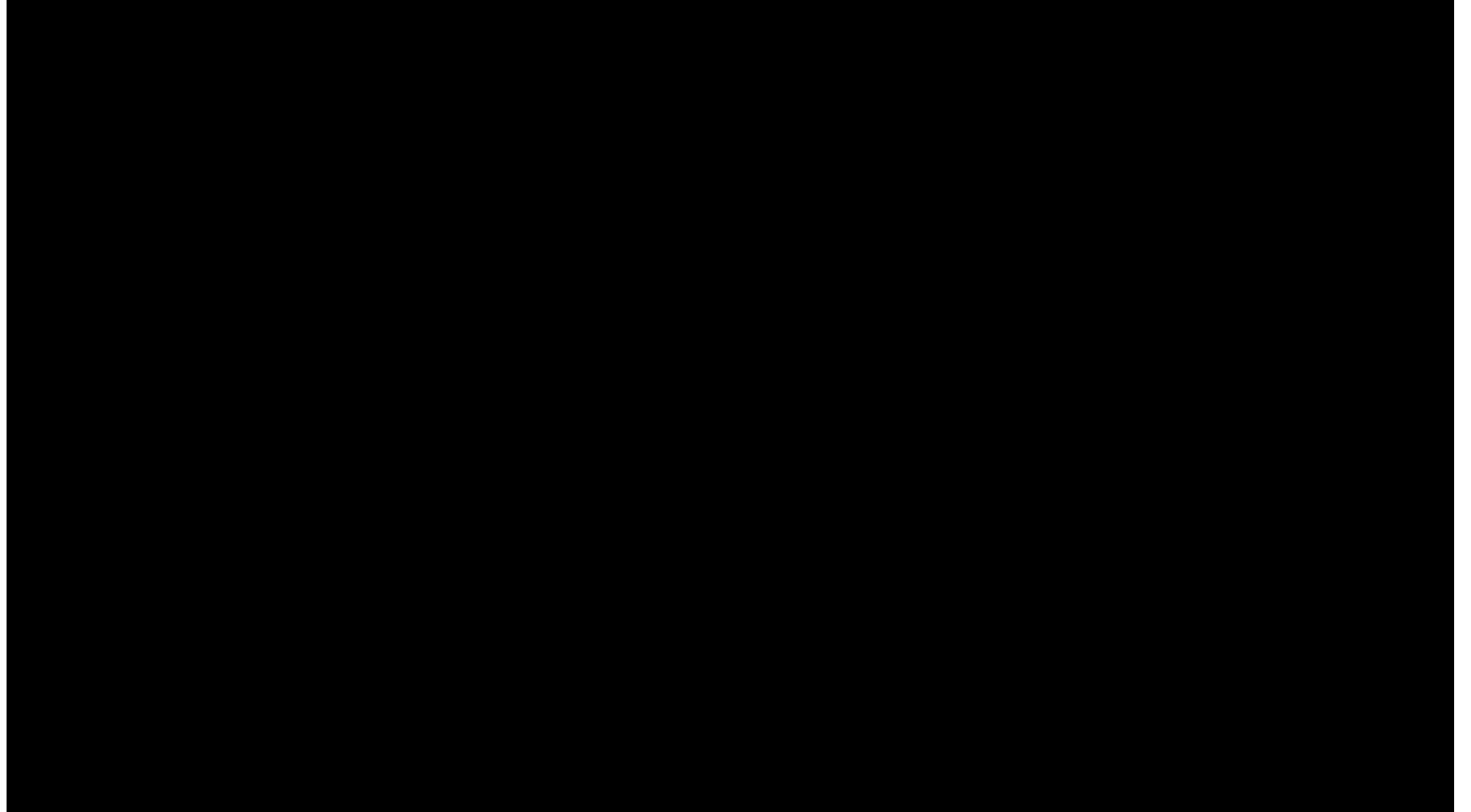

RSA Algorithm

Ron Rivest, Adi Shamir,
Leonard Adelman (1976)
public discovery

1970 GCHQ (from Bletchley)
discovered the idea but
couldn't publish (announced
in 1997)

Popularized when
implemented in ARPANET

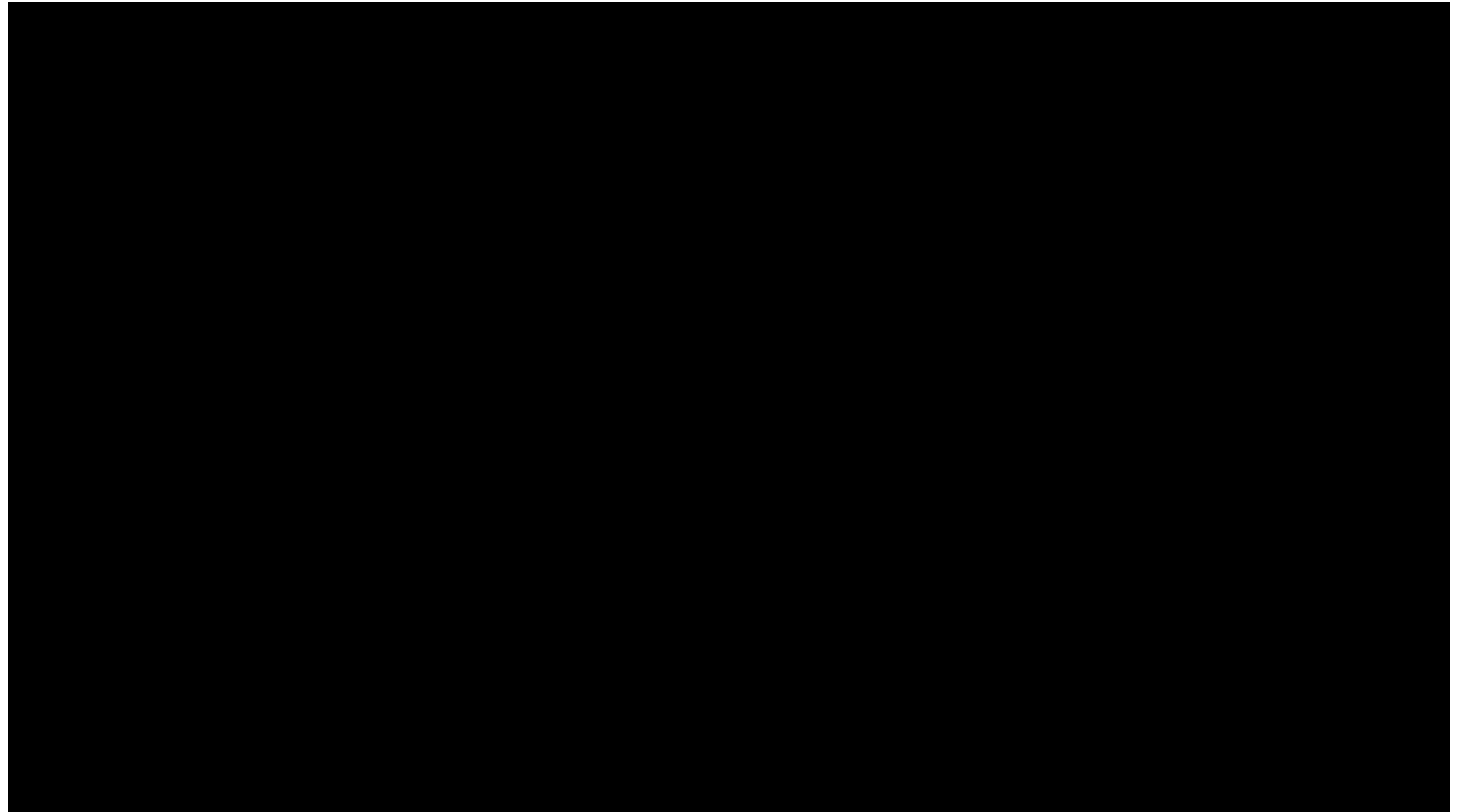

ARPANET

Advanced Research Projects Agency Network (ARPANET) was an early packet switching network and the first network to implement the protocol suite TCP/IP. (1969)

TCP/IP layers of protocols to handle different levels of communications. (Vint Cerf, father of internet)

Where internet came from.

Was not invented by one person. Many different people over many years.



Steve Wozniak

Wozniak was the computer scientist

Steve Jobs was more of the businessman.

Pioneer of personal computer, many were doing it. HP where he worked passed on Apple I design.

Apple I (1976)

Apple II (1977)

Apple I like ALTAIR which worked in BASIC (first home micro computer) but Apple I was hobbyist machine



Bill Gates

Businessman

Bill Gates and Paul Allen founded Microsoft in 1975

ALTAIR was first big popular microcomputer made by MITS

They made Altair BASIC

BASIC (1964) – high level programming language, that let your write programs, popular on microcomputers, many many different versions, let homebrewers write their own code easier

Then Microsoft worked with IBM on a version of DOS (an OS program that could launch other programs within it)

Key to Windows after was understanding people wanted to be sold a solution that worked across platforms (standardization)

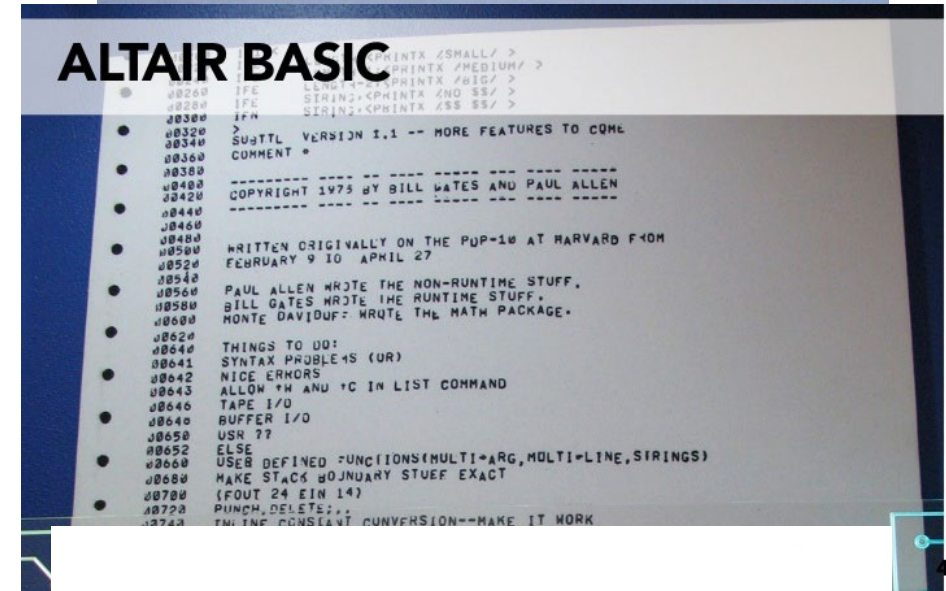
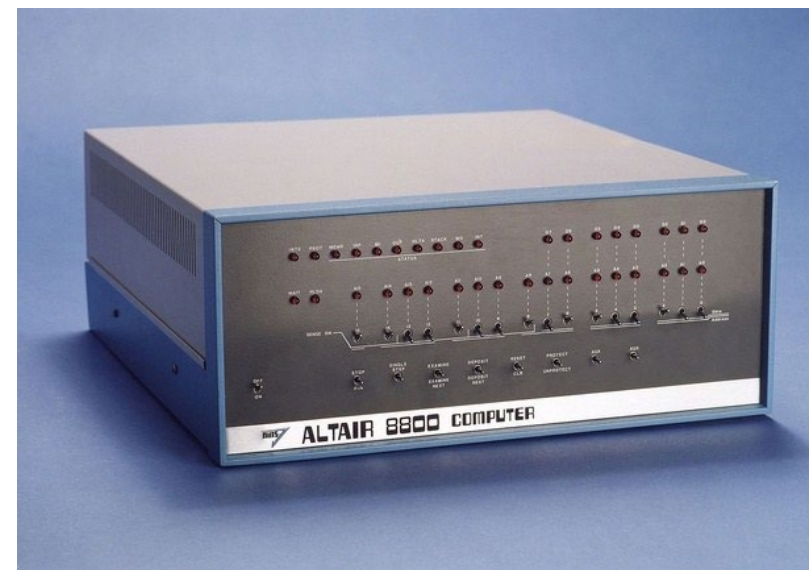

Bill Gates

Businessman

Bill Gates and Paul Allen founded Microsoft in 1975

ALTAIR was first big popular microcomputer made by MITS

They made Altair BASIC

BASIC (1964) – high level programming language, that let your write programs, popular on microcomputers, many many different versions, let homebrewers write their own code easier

Then Microsoft worked with IBM on a version of DOS (an OS program that could launch other programs within it) [MS-DOS 1981]

Windows 1.0 (1985)

Key to Windows after was understanding people wanted to be sold a solution that worked across platforms (standardization)

```
Welcome to FreeDOS

CuteMouse v1.9.1 alpha 1 [FreeDOS]
Installed at PS/2 port
C:\>ver

FreeCom version 0.82 pl 3 XMS_Swap [Dec 10 2003 06:49:21]

C:\>dir
Volume in drive C is FREEDOS_C95
Volume Serial Number is 0E4F-19EB
Directory of C:\

FDOS          <DIR>    08-26-84   6:23p
AUTDEXEC.BAT  435     08-26-84   6:24p
BOOTSECT.BIN  512     08-26-84   6:23p
COMMAND.COM   93,963  08-26-84   6:24p
CONFIG.SYS    801     08-26-84   6:24p
FDOSBOOT.BIN  512     08-26-84   6:24p
KERNEL.SYS    45,815  04-17-84   9:19p
6 file(s)    142,838 bytes
1 dir(s)    1,064,517,632 bytes free

C:\>
```

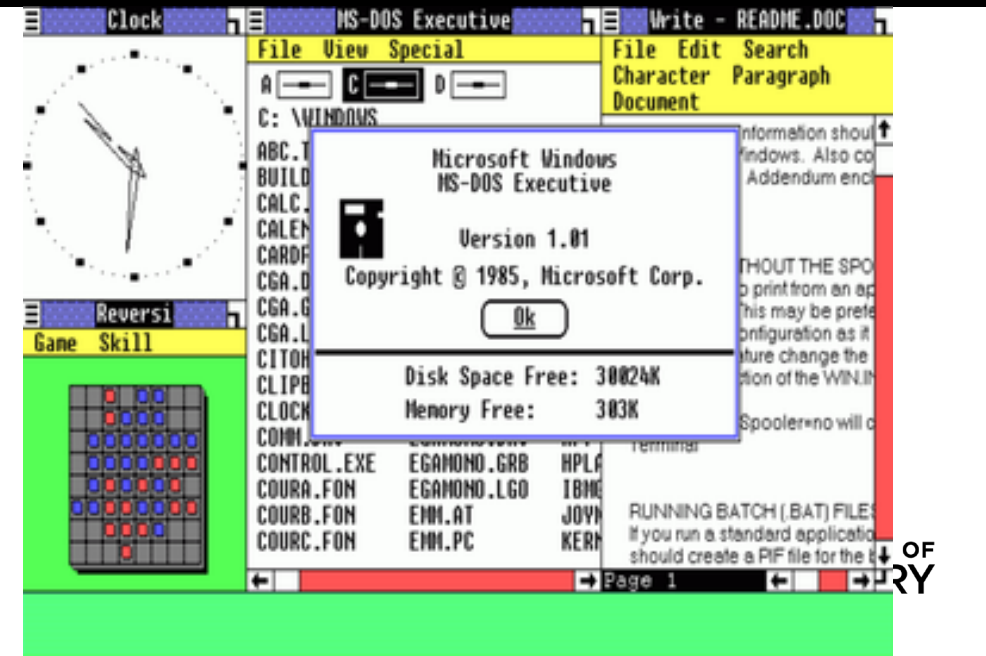

Brief History of OS

The first personal computer which used a modern graphical user interface was the Xerox Alto, developed in 1973.

XEROX 8010 Star (1981)

Apple Lisa (1983)

Mac OS 1.0 (1984)

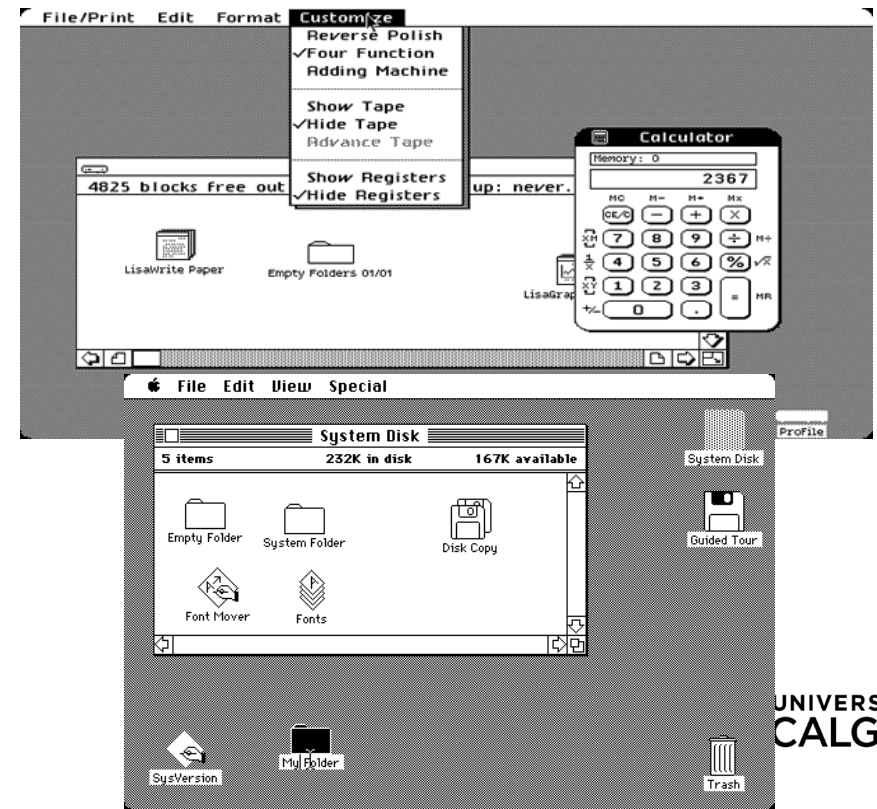
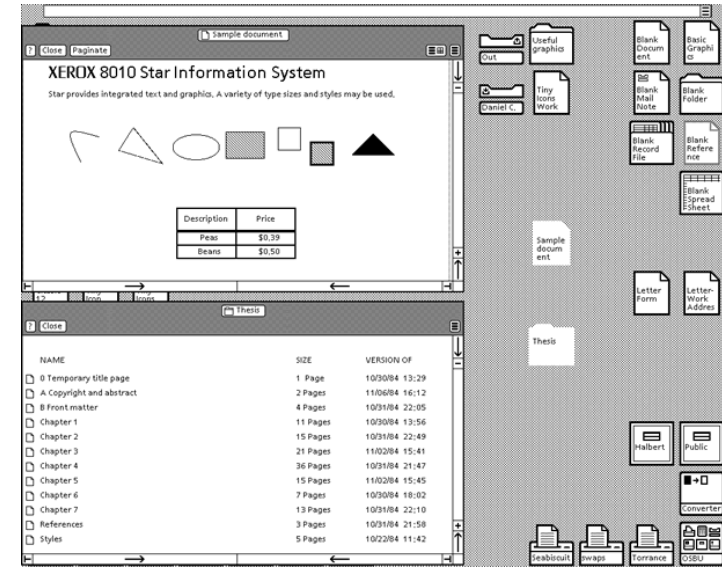
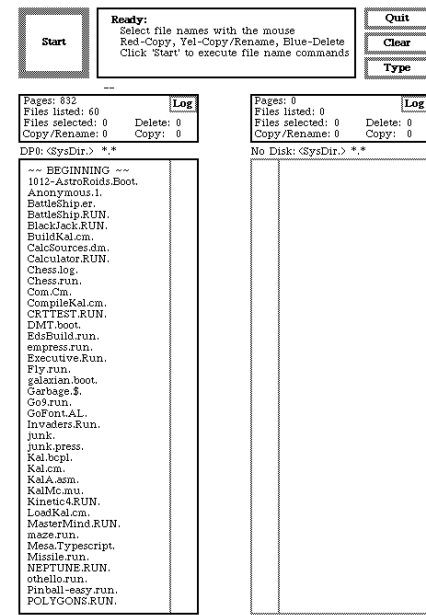

Brief History of OS

Windows 1.0 (1985)

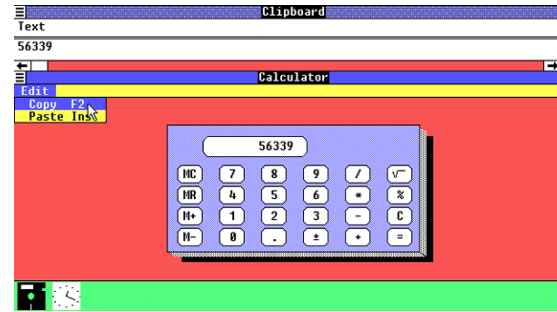

NeXTStep 1.0 (1989)

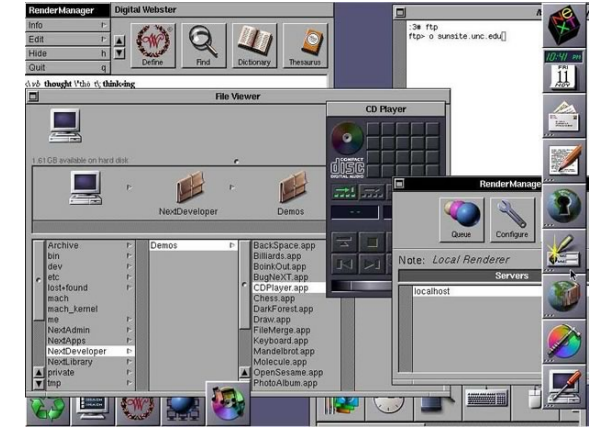

Windows 95 (1995)



Mac OS X (2001) -> High unix, Jobs returns with NeXT ideas



Windows XP (2001)

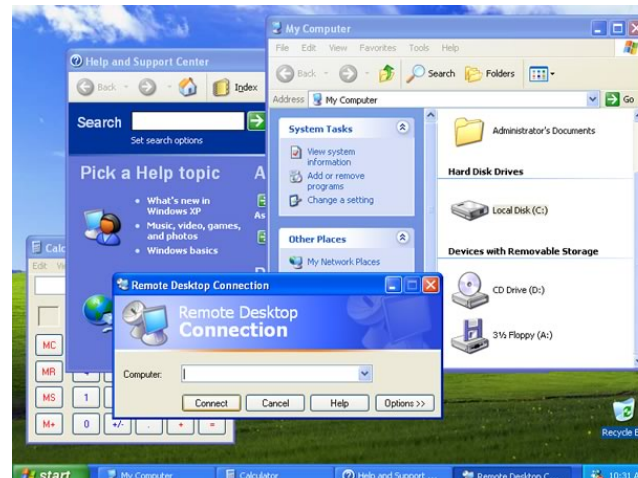

First Browser

Tim Berners-Lee (1990)

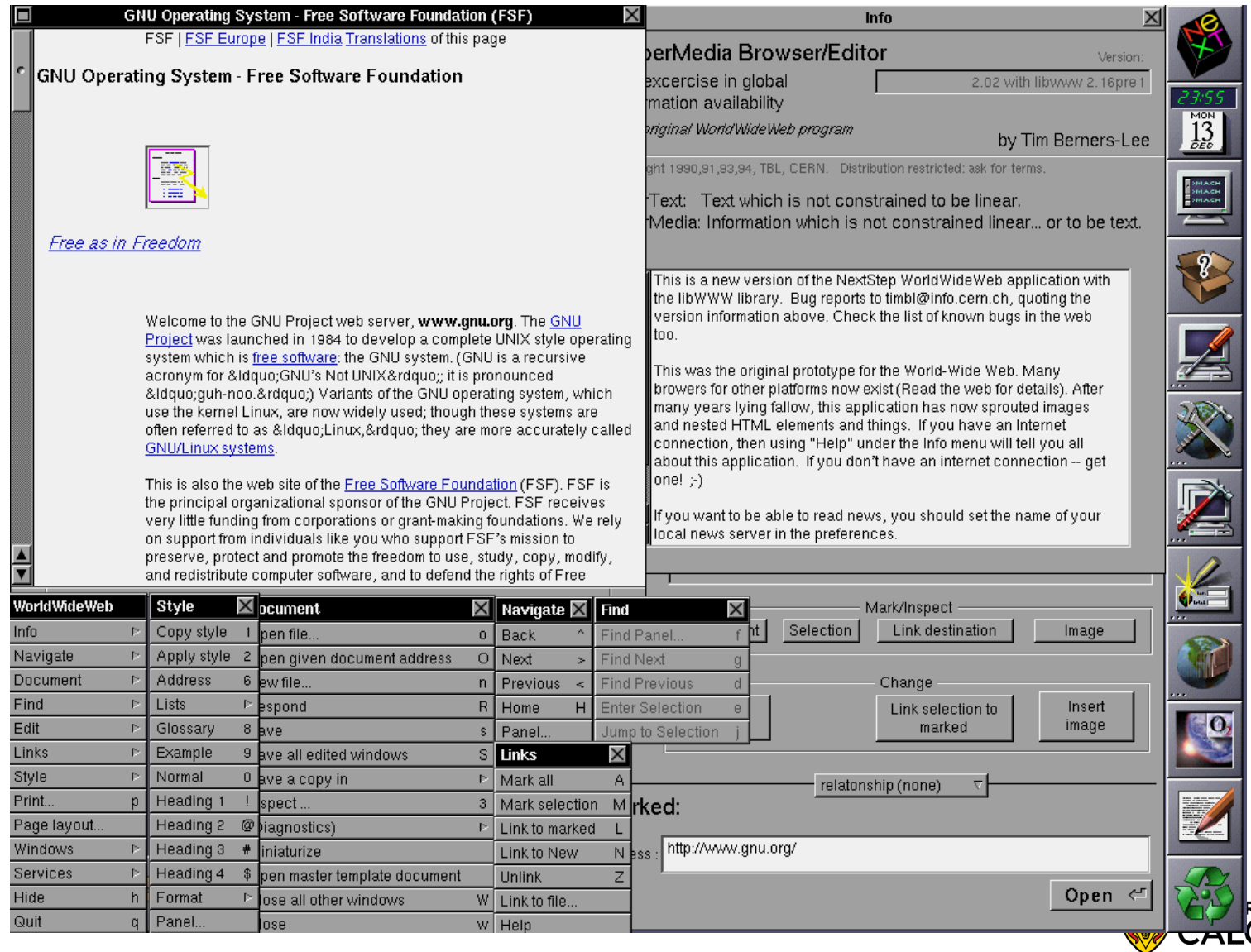

James Gosling

Snuck into CPSC labs at UofC while in high school at William Aberhart (1973)

Bachelor of Science UofC

MA, PhD Carnegie Mellon

Created Java (1995) while with Sun Microsystems

Key idea is the Java VM (virtual machine) write code once and run it anywhere (don't compile to machine code, compile to a midform byte code and make specific vm for each specific hardware)



Steve Jobs

Originally involved with Wozniak with Apple I
With Apple until 1985

1986 helped fund the LucasFilm spinoff Pixar

With NeXT until 1997, people like graphics

User friendly became selling point

Two main targets, creatives and non business

Popularization of iPod, found success with
minimalization (less of a computer)

Popularization of modern smartphone, tablet

All concepts existed in computer science, just
addition of single minded HCI focus

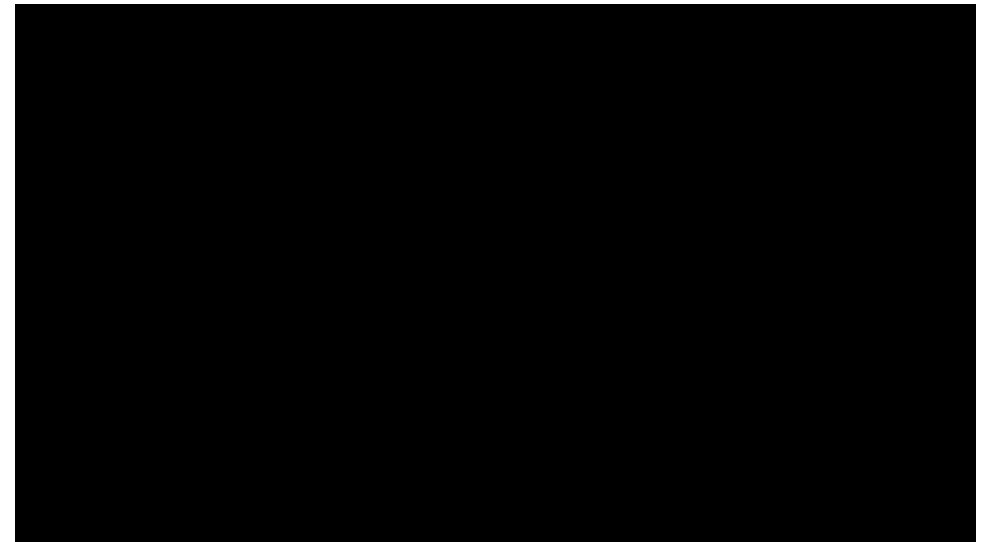
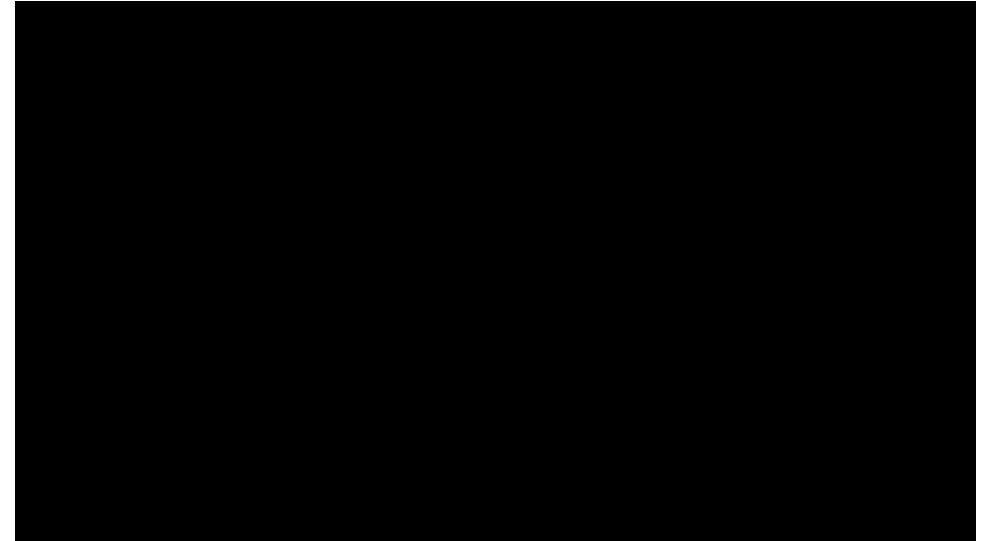

Steve Jobs

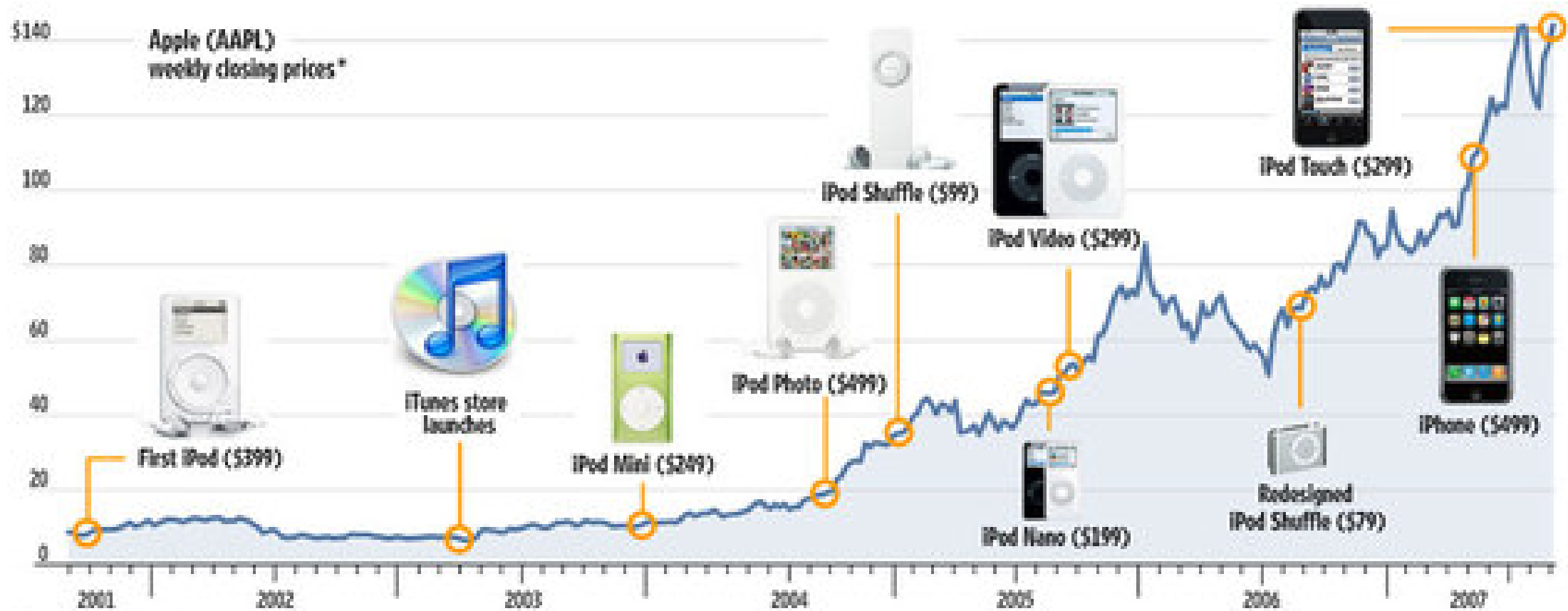

* Starting Sept. 2, 2001
Source: SunGard PowerData

Shor's Algorithm

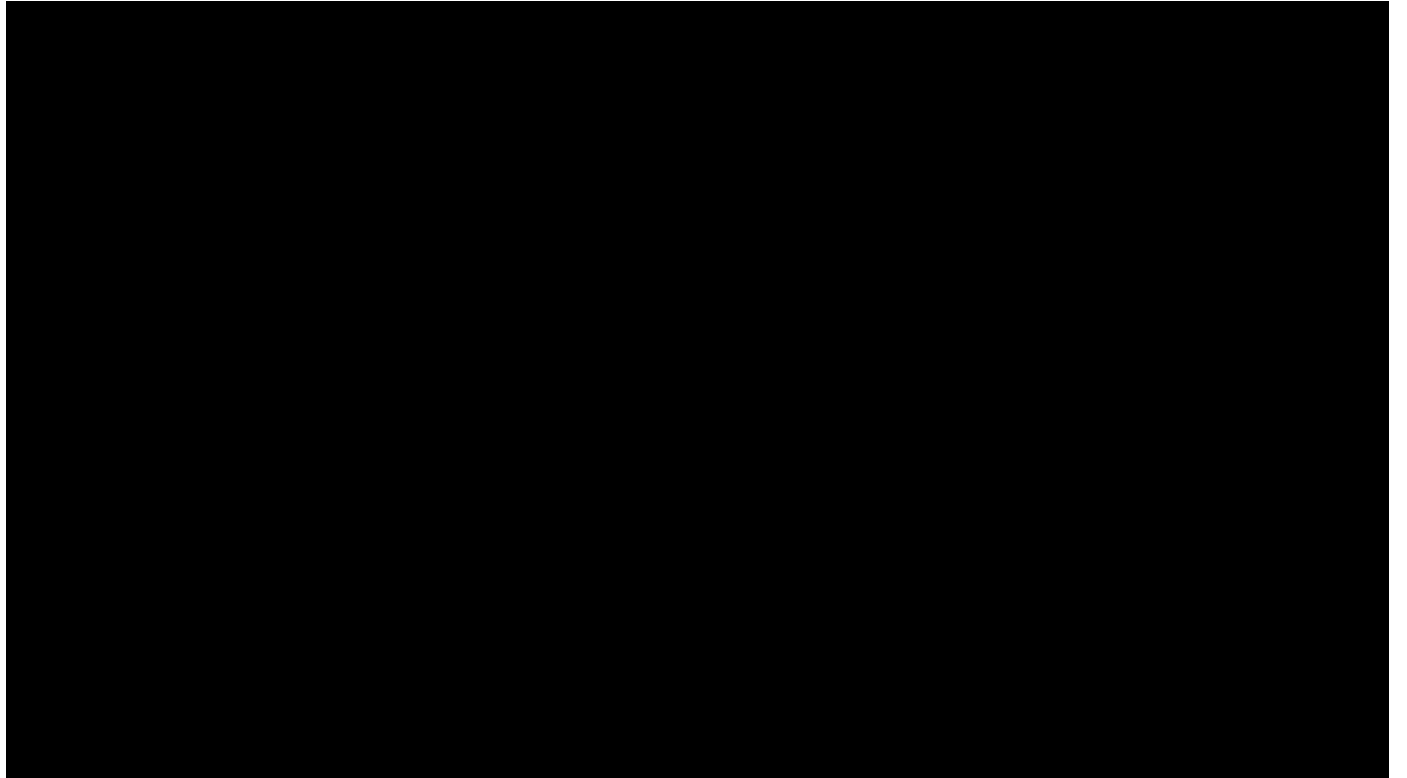

Modern Computers

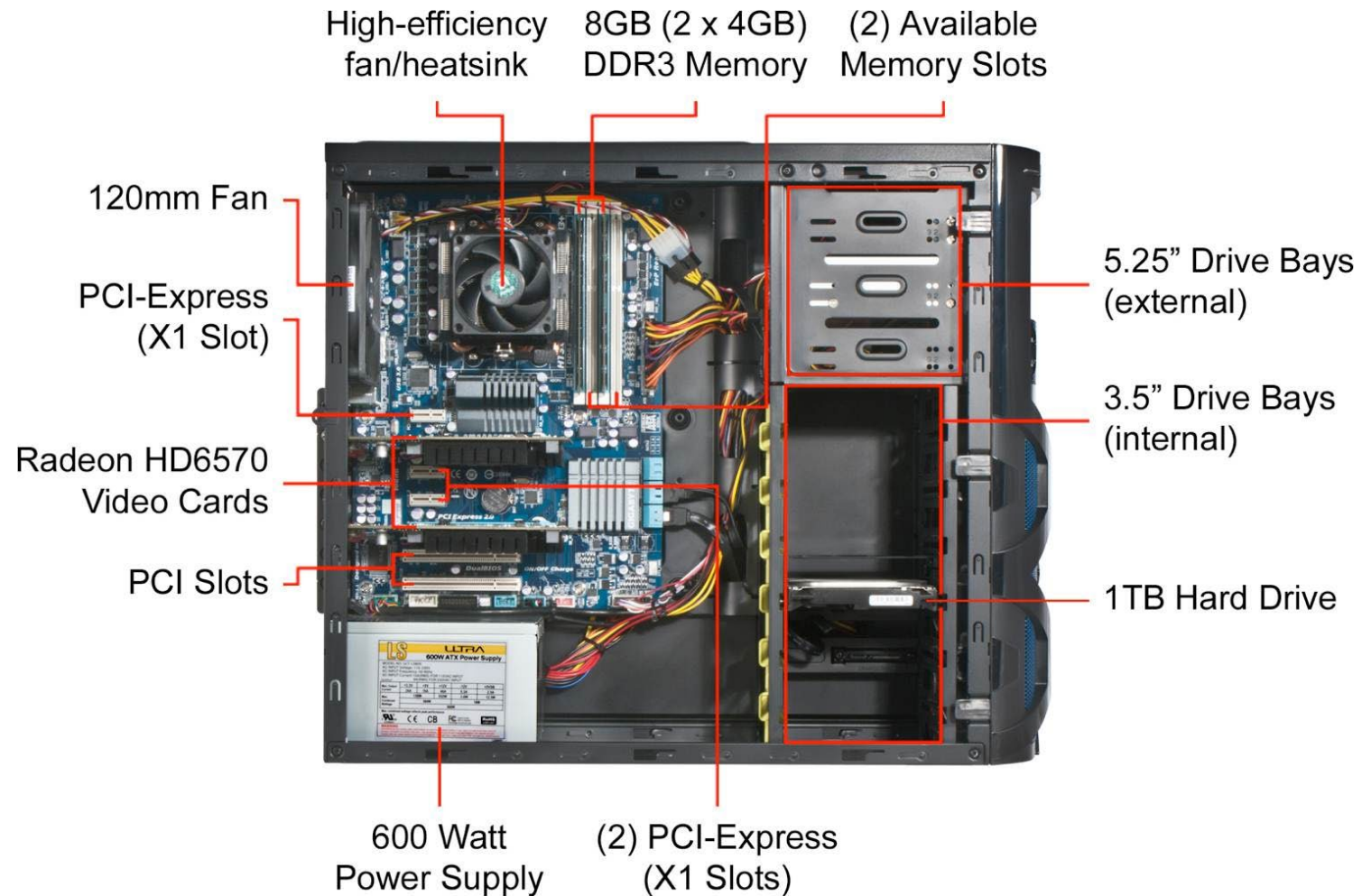

Modern Computers

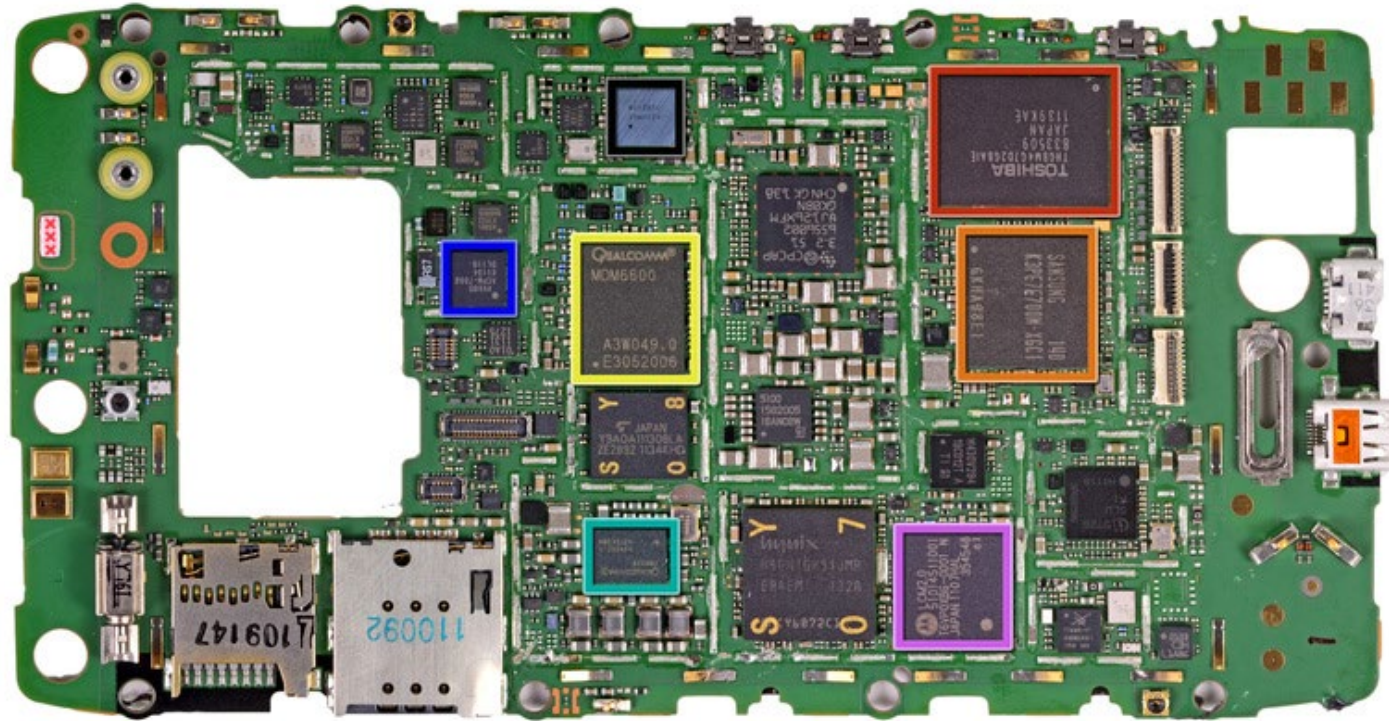

Modern Computers



Onward to ... CPSC 233.

Jonathan Hudson
jwhudson@ucalgary.ca
<https://pages.cpsc.ucalgary.ca/~hudsonj/>



UNIVERSITY OF
CALGARY